

**THIRD
EDITION**



Union Special
INDUSTRIAL SEWING EQUIPMENT

CATALOG NO. 78M

STYLES

41300

CUP FEED MACHINES

Catalog No. 78 M

LIST OF PARTS

STYLES IN CLASS

41300

CUP FEED MACHINES

Third Edition

Copyright 1948

by

Union Special Machine Co.
Rights Reserved in All Countries

Union Special

MACHINE COMPANY

INDUSTRIAL SEWING MACHINES

CHICAGO

Printed in U.S.A.

June, 1969

FOREWORD

It is our constant aim to furnish carefully prepared information that will enable the customer to secure all possible economies and advantages from the use of Union Specials. On the pages which follow will be found illustrations and descriptions of the parts for styles in Class 41300 - Cup Feed Machines.

Additional catalogs, containing information relative to these machines, and which will be furnished upon request, are listed below.

Catalog No. 45 N Needle Manual
Catalog No. 78 Instructions for Installing
Form 357 Engineering Department
Adjusting Instructions.
Specify the style number of
the machine for which the
adjusting instructions are
required.

In all manufacturing centers will be found Union Special representatives, who will cooperate with those who desire in planning and estimating their requirements.

Union Special MACHINE COMPANY

Engineering Department

IDENTIFICATION OF MACHINES

Each Union Special carries a style number which is stamped in the name plate on the machine. Style numbers are classified as standard and special. Those which are standard have one or more letters suffixed, but never contain the letter "Z". Example: 41300 A. Style numbers containing the letter "Z" are special. When only minor changes are made in a standard machine a "Z" is merely suffixed to the respective standard style number. Example: 41300 AZ.

Styles of machines similar in construction are grouped under a class number which differs from the style numbers in that it contains no letters. Example: 41300.

APPLICATION OF CATALOG

This catalog applies only to the standard styles of machines as listed herein. It can also be applied with discretion to the special machines in Class 41300.

STYLES OF MACHINES IN CLASS 41300

Cup Feed Machines, Overedge Stitch, Gear Driven Outer Cup

41300 A (Succeeds 41200 AA) For seaming chiffon weight full fashioned silk hosiery commonly known as 1, 2, and 3 thread, two end stitch, Type 503, stitch range 22 to 14 per inch, Type 155 A needle.

41300 B For seaming all weights full fashioned silk hosiery, two end stitch, Type 503, stitch range 22 to 14 per inch, Type 155 A needle.

41300 C For seaming chiffon weight full fashioned silk hosiery commonly known as 1, 2, and 3 thread, three end stitch, Type 504, stitch range 22 to 14 per inch, Type 155 A needle.

41300 D For seaming all weights full fashioned silk hosiery, three end stitch, Type 504, stitch range 22 to 14 per inch, Type 155 A needle.

41300 E For mock seaming all weights hosiery, two end stitch, stitching spec. 503-OSf-1, stitch range 22 to 14 per inch, Type 155 A needle.

41300 F (Succeeds 41300 A). For seaming chiffon weight full fashioned silk hosiery commonly known as 1, 2, and 3 thread, two end stitch, seam spec. 503-SSa-1, stitch range 22 to 14 per inch, Type 155 A needle.

41300 G (Succeeds 41300 B). For seaming all weights full fashioned silk hosiery, two end stitch, seam 503-SSa-1, stitch range 22 to 14 per inch, Type 155 A needle.

STYLES OF MACHINES IN CLASS 41300 (Cont'd.)

- 41300 H (Succeeds 41300 C). For seaming chiffon weight full fashioned silk hosiery commonly known as 1, 2, and 3 thread, three end stitch, seam spec. 504-SSa-1, stitch range 22 to 14 per inch, Type 155 A needle.
- 41300 J (Succeeds 41300 D). For seaming all weights full fashioned silk hosiery, three end stitch, seam spec. 504-SSa-1, stitch range 22 to 14 per inch, Type 155 A needle.
- 41300 K Same as 41300 F, except equipped for seaming 30 to 40 denier nylon hosiery, equivalent in weight to two and three thread silk hosiery, Type 155 A needle.
- 41300 L Same as 41300 G, except equipped for seaming all weights nylon hosiery, pulling attachment, Type 155 A needle.
- 41300 M Same as 41300 H, except equipped for seaming 30 to 40 denier nylon hosiery, equivalent in weight to two and three thread silk hosiery, automatic thread ratio control and pulling attachment, Type 155 A needle.
- 41300 N Same as 41300 J, except equipped for seaming all weights nylon hosiery, automatic thread ratio control and pulling attachment, Type 155 A needle.
- 41300 P For seaming chiffon weight full fashioned silk hosiery commonly known as 1, 2, and 3 thread, with circular heel and continuous seam from toe to welt, three end stitch, seam spec. 504-SSa-1, stitch range 22 to 14 per inch, knee controlled device for increasing height of uncurler, and automatic thread ratio control, Type 155 A needle.
- 41300 Q Same as 41300 P, except equipped for seaming all weights full fashioned silk hosiery, with circular heel and continuous seam from toe to welt, Type 155 A needle.
- 41300 R Same as 41300 P, except equipped for seaming 30 to 40 denier nylon hosiery, with circular heel and continuous seam from toe to welt, equivalent in weight to two and three thread silk hosiery, Type 155 A needle.
- 41300 S Same as 41300 P, except equipped for seaming all weights nylon hosiery, with circular heel and continuous seam from toe to welt, Type 155 A needle.
- 41300 T (Succeeds 41300 F, 41300 G, 41300 H, 41300 J, 41300 M, 41300 N, 41300 P, 41300 Q, 41300 R, 41300 S). For seaming all weights of cotton, rayon, silk, or nylon full fashioned hosiery, with circular heel and continuous seam from toe to welt, or conventional square heel. Equipped for both two end and three end stitch, seam specifications 503-SSa-1 or 504-SSa-1, stitch range 14 to 22 per inch, needle guard and stitch tongue support .065 inch

STYLES OF MACHINES IN CLASS 41300 (Cont'd)

41300 T (Cont'd) high, knee controlled device for increasing height of uncurler, automatic thread ratio control for three end stitch, fabric pulling and chain cutting attachment, Type 155 A needle.

41300 U (Succeeds 41300 F, 41300 G). Same as 41300 T except equipped for two end stitch, seam specification 503-SSa-1 only.

41300 V (Succeeds 41300 H, 41300 J, 41300 M, 41300 N) Same as 41300 T except equipped for three end stitch, seam specification 504-SSa-1 only.

41300 W Same as 41300 T, except equipped with needle guard and stitch tongue support .055 inch high.

41300 Z A special style, similar to the standard styles in Class 41300, but differing in one or more of its component parts.

ORDERING REPAIR PARTS

PLATES

Illustrations of parts are arranged according to scale and, wherever possible, parts similar in appearance or function are grouped together.

When a given design of part is made in two or more sizes, only one illustration is usually shown. In ordering these pieces, it is necessary that the additional information be furnished as requested under these illustrations.

LIST OF PARTS

Turning from the plates to the list of parts, the description of each part and its principal uses will be found. Always check the symbol against its description before ordering. It is not necessary to furnish the plate number.

When a part is used, or can be used, in all machines covered by this catalog, no specific use is mentioned in the description.

For convenience in ordering, minor parts such as screws, nuts and similar articles are repeated after each major part.

(-) A dash in the "plate number" column of the list of parts indicates the absence of an illustration.

(‡) A double dagger in the "symbol to order by" column indicates that the component parts cannot be furnished separately. Due to the high speed of these machines and other factors it is impossible for these associated parts to be fitted a second time and make a serviceable job.

ORDERING REPAIR PARTS (Continued)

IDENTIFYING PARTS

Where the construction permits, each part is stamped with its part number. On some of the smaller parts, and on those where construction does not permit, an identification letter is stamped in to distinguish the part from similar ones.

Part numbers represent the same part, regardless of catalog in which they appear.

IMPORTANT! ON ALL ORDERS, PLEASE INCLUDE PART NAME AND STYLE OF MACHINE FOR WHICH PART IS ORDERED.

SUPPLIES

All supplies, including taps, reamers, belting, belt hooks, belt fasteners, screwdrivers, wrenches and powdered oil stone will be promptly furnished.

USE GENUINE NEEDLES AND REPAIR PARTS

Success in the operation of these machines can be secured only with genuine Union Special Needles and Repair Parts as furnished by the Union Special Machine Company, its subsidiaries and authorized distributors. They are designed according to the most approved scientific principles, and are made with utmost precision. Maximum efficiency and durability are assured.

Genuine needles are packaged with labels marked *Union Special*. Genuine repair parts are stamped with a reproduction of the familiar Union Special trade mark. Each trade mark is your guarantee of the highest quality in materials and workmanship.

TERMS

Prices are net cash and subject to change without notice. All shipments are forwarded f. o. b. shipping point. Parcel Post shipments are insured unless otherwise directed. A charge is made to cover postage and insurance.

Plate 1 - Full Size

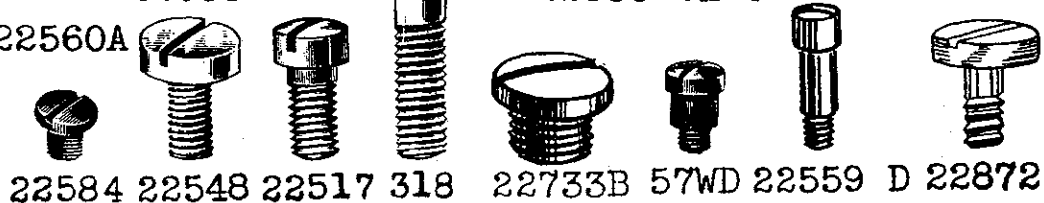
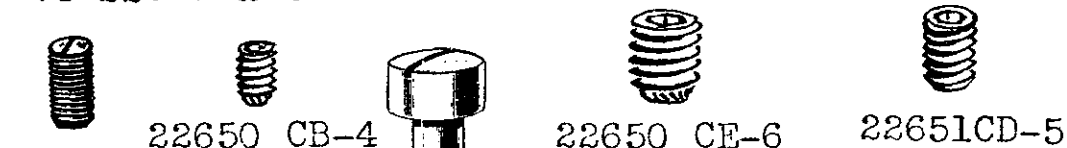
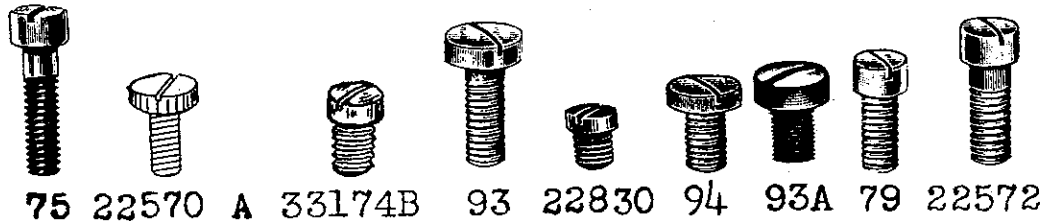
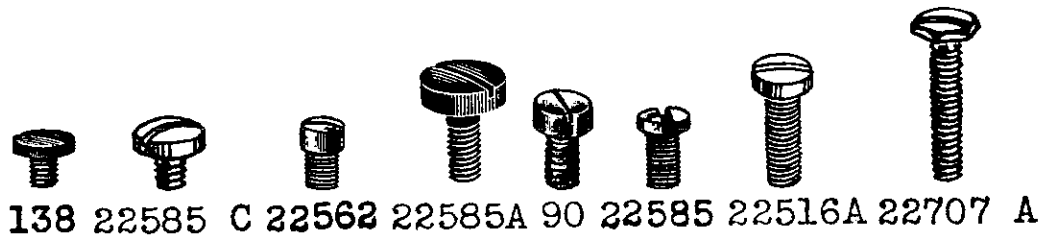
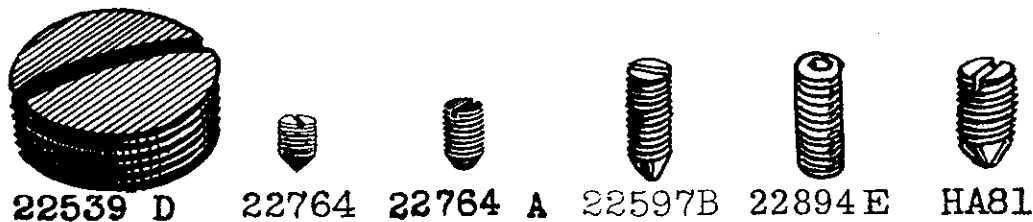
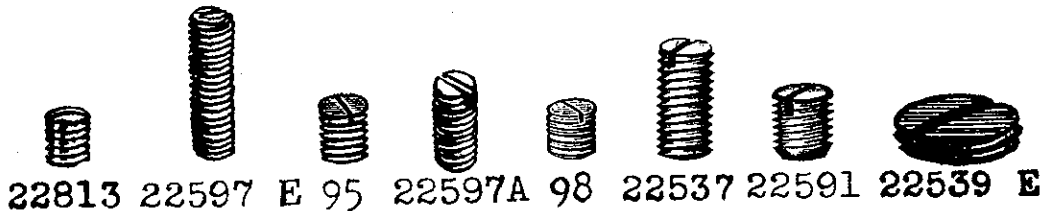
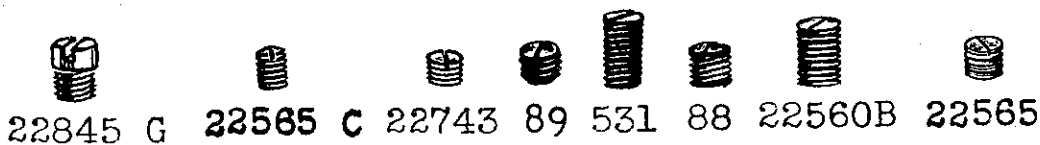

Plate 2 - Full Size

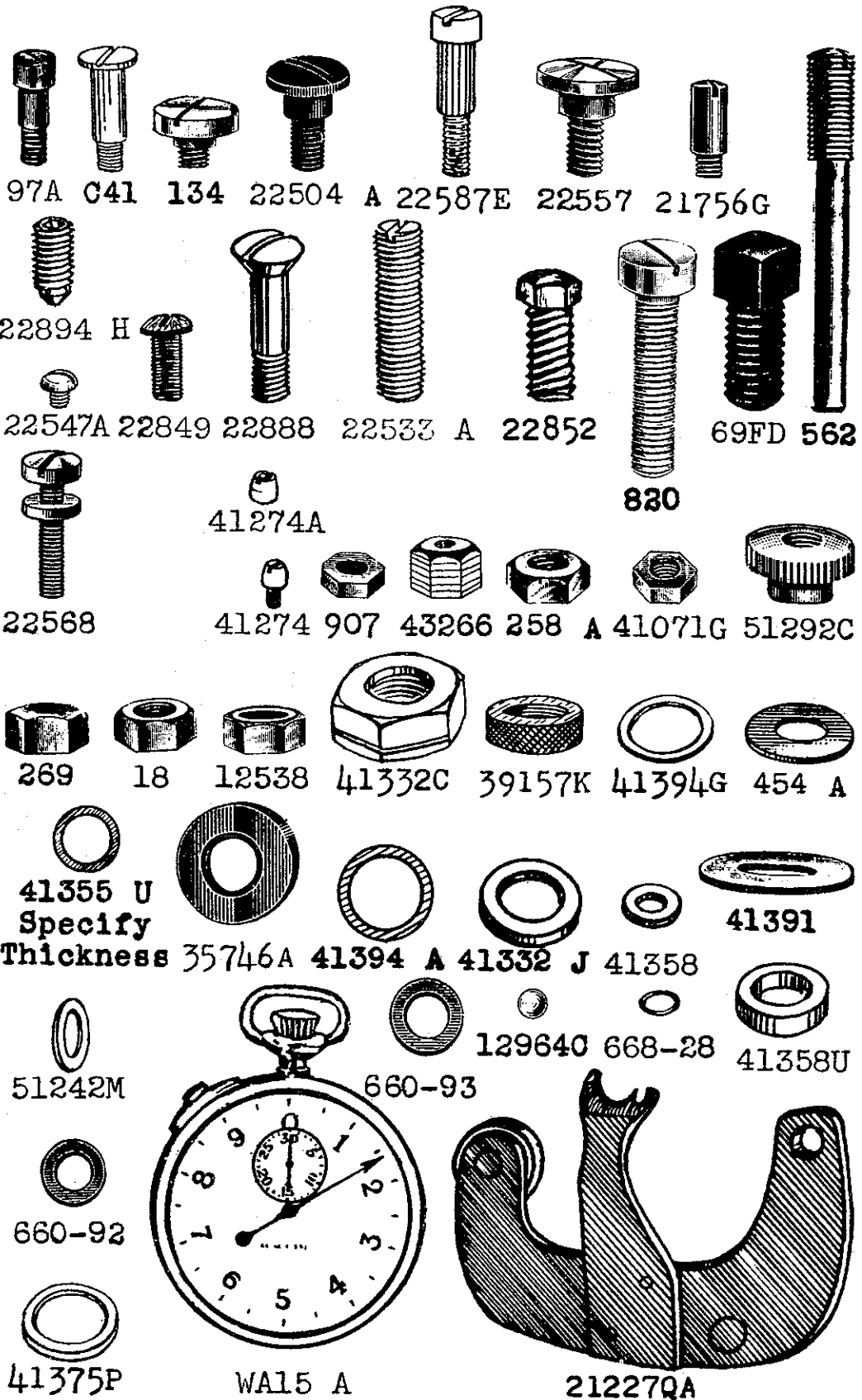

Plate 3 - Full Size

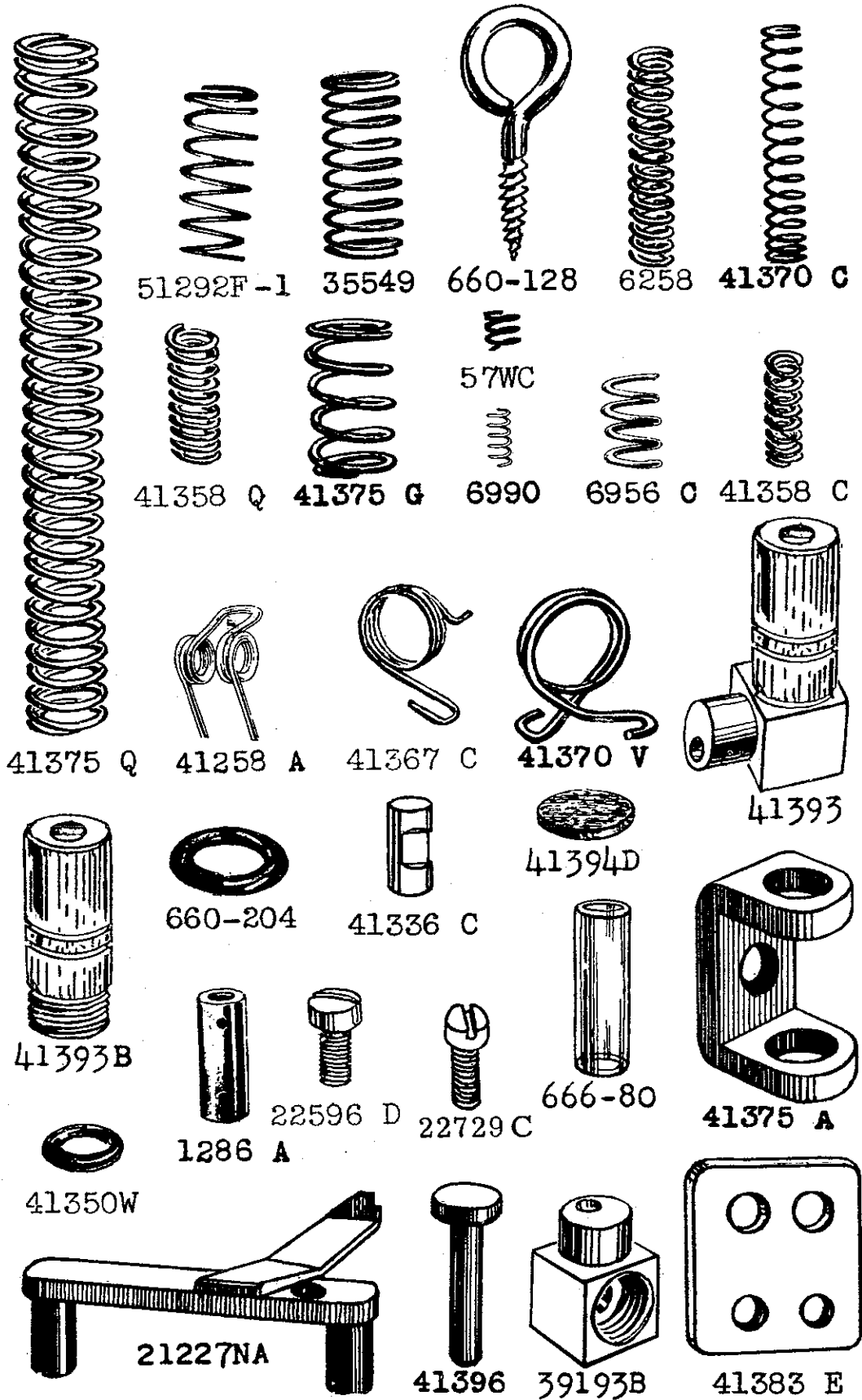
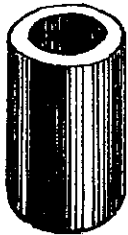

Plate 4 - Full Size



41332 B



41357 N

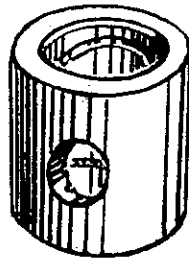

41390 E



21113B

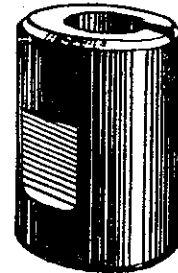

41364 N



41363 U

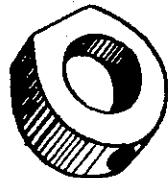

41375 F

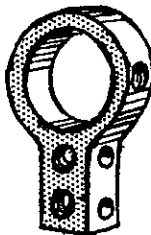

41343 C

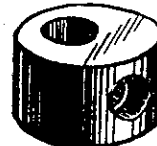

41360 G

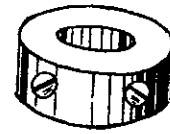

39147 D



41258

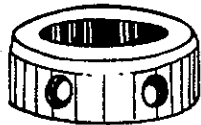

2339 F

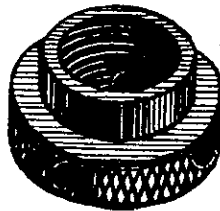

41375 V



41039 A



41350 G



41037 A

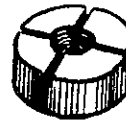

41355

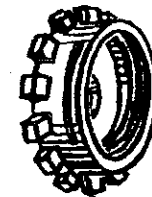

41350 V



41332A

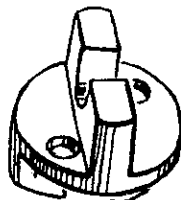

41363N



660-142



41332 P

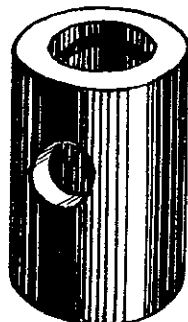

41390 D

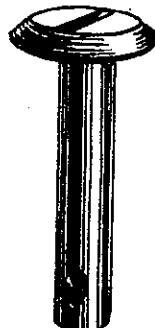

41360



41361 J



41350U

Plate 5 - Full Size

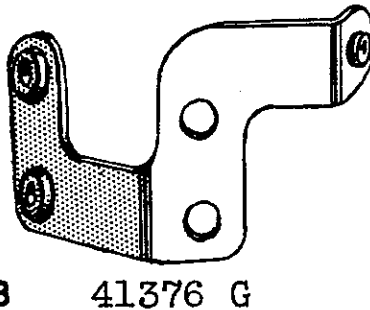
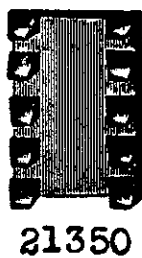
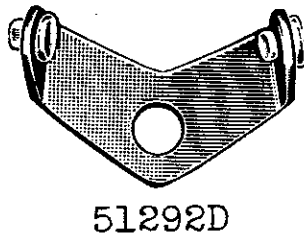
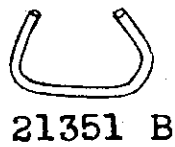
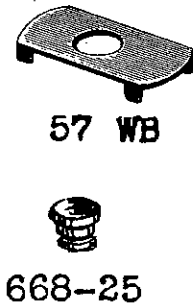
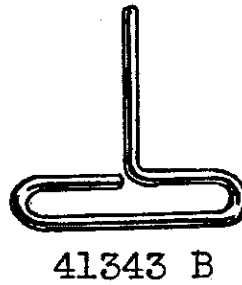
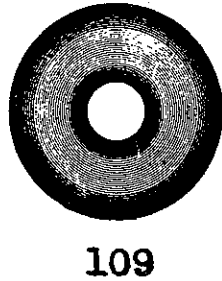
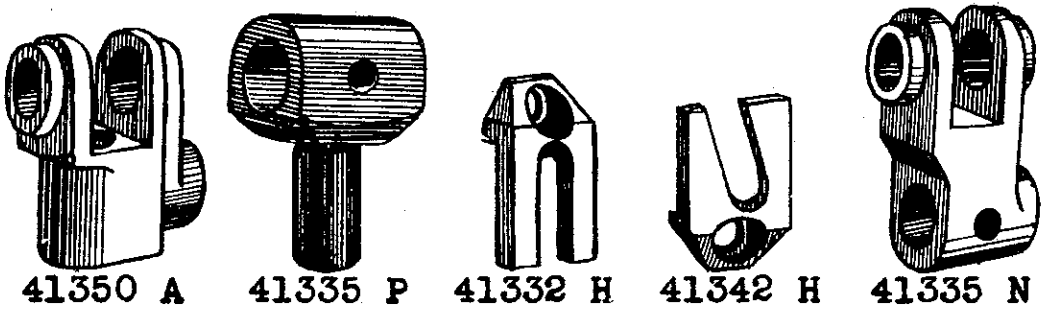
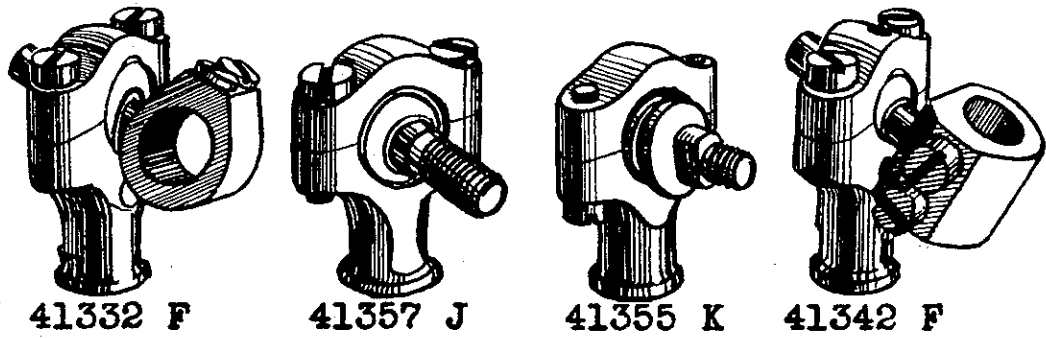

Plate 6 - Full Size

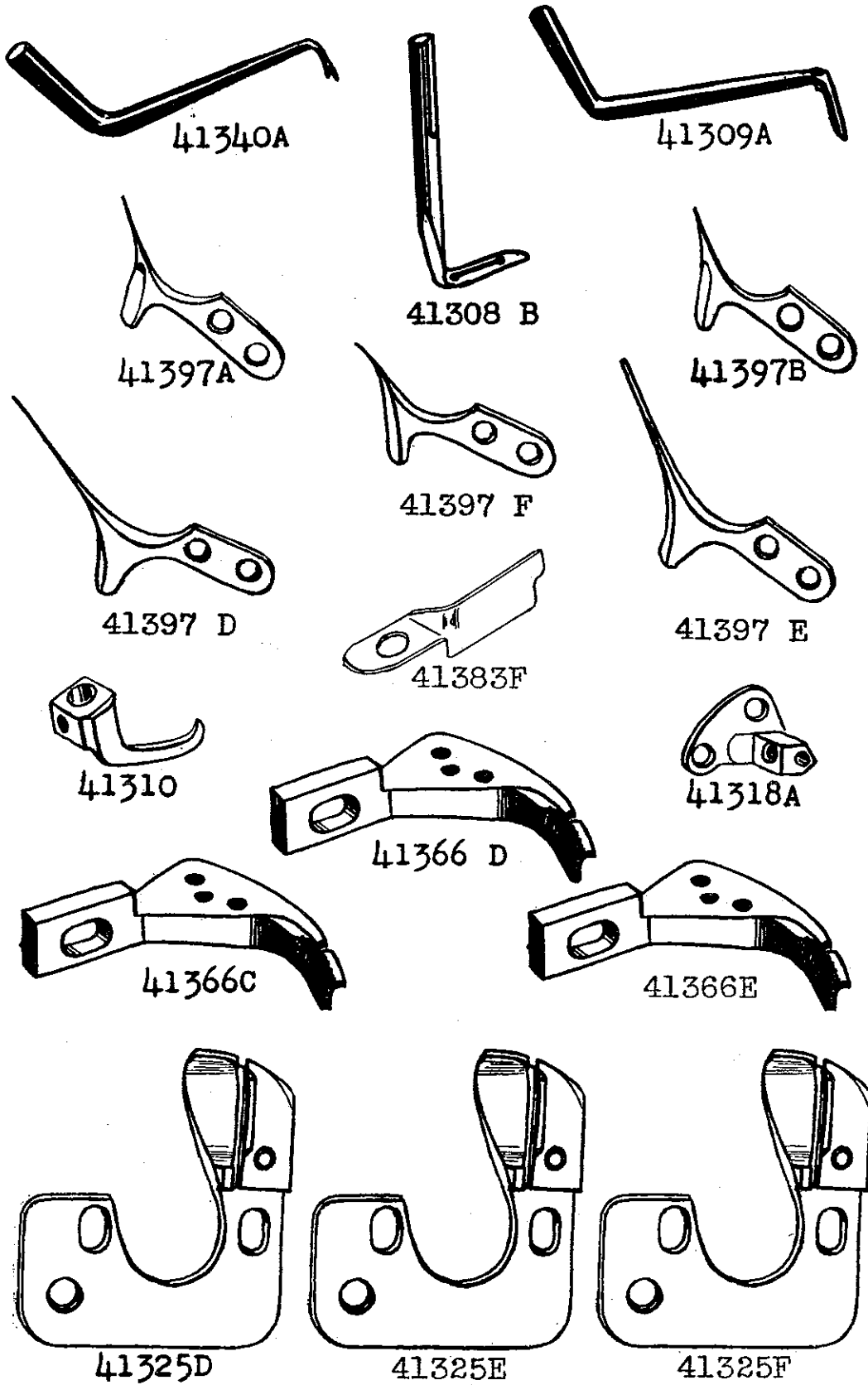
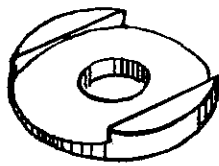
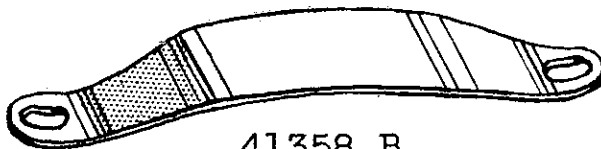

Plate 7 - Full Size



41358 A



41358 B



41370AG

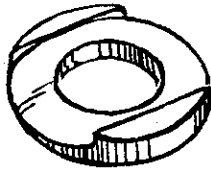

41358 R



41358 D

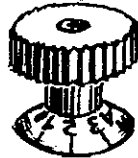

41370AF



41370 U



41358 T

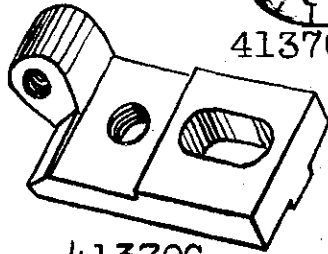

41370G

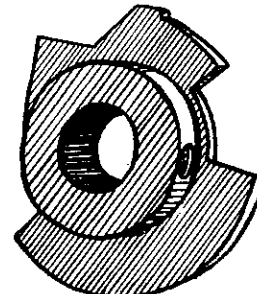

41370 N

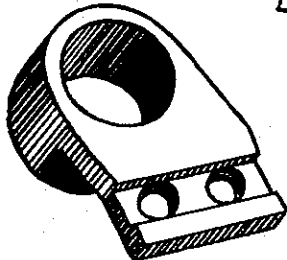

41370 A



41370AE



41370AC

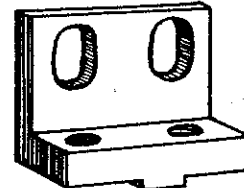

41366 N

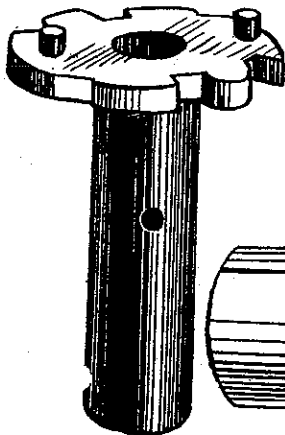

41370 P

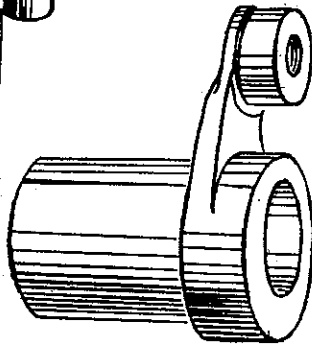

41370 AH

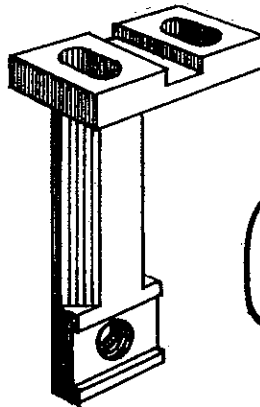

41366 G



41358 S

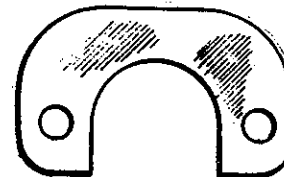

41345 G
Specify
Thickness

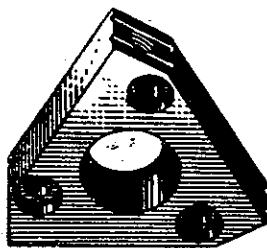

41258B

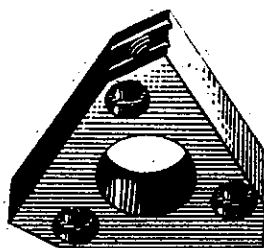

41258 E

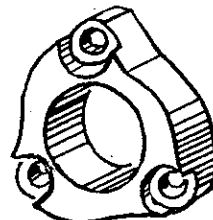

41358 N

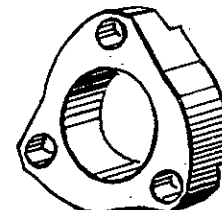

41358 P

Plate 8 - Full Size

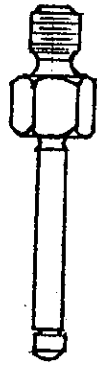

41378 X

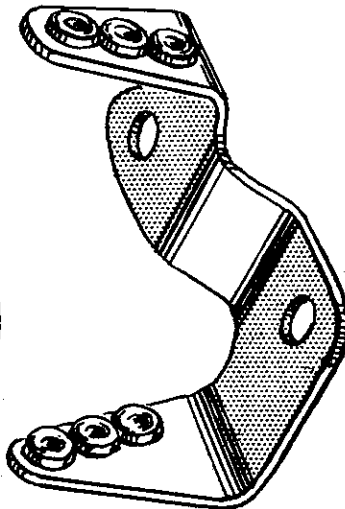

41378



41395 B

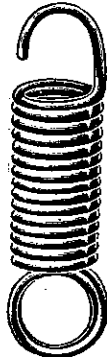

426

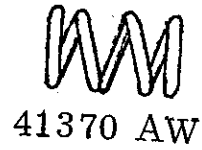

41370 AW



41378 J



50-216 Blk.

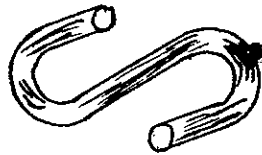

660-264



41350 X



41332 L

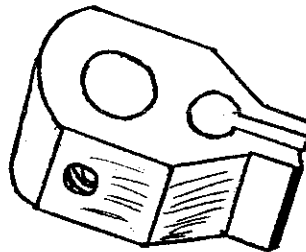

41370 BD



41370 AX



41370 AY



660-210



41378 K



41367 G

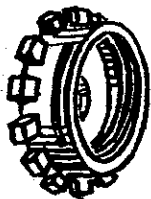

41332 K

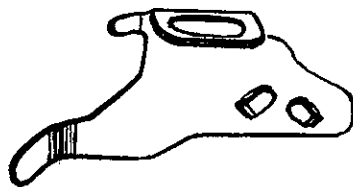

41367 J

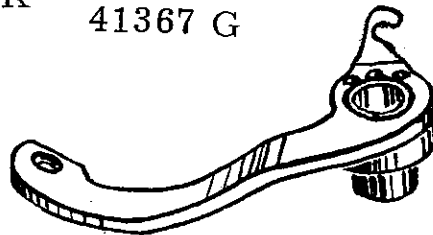

41367 R

Plate 9 - One-Half Size

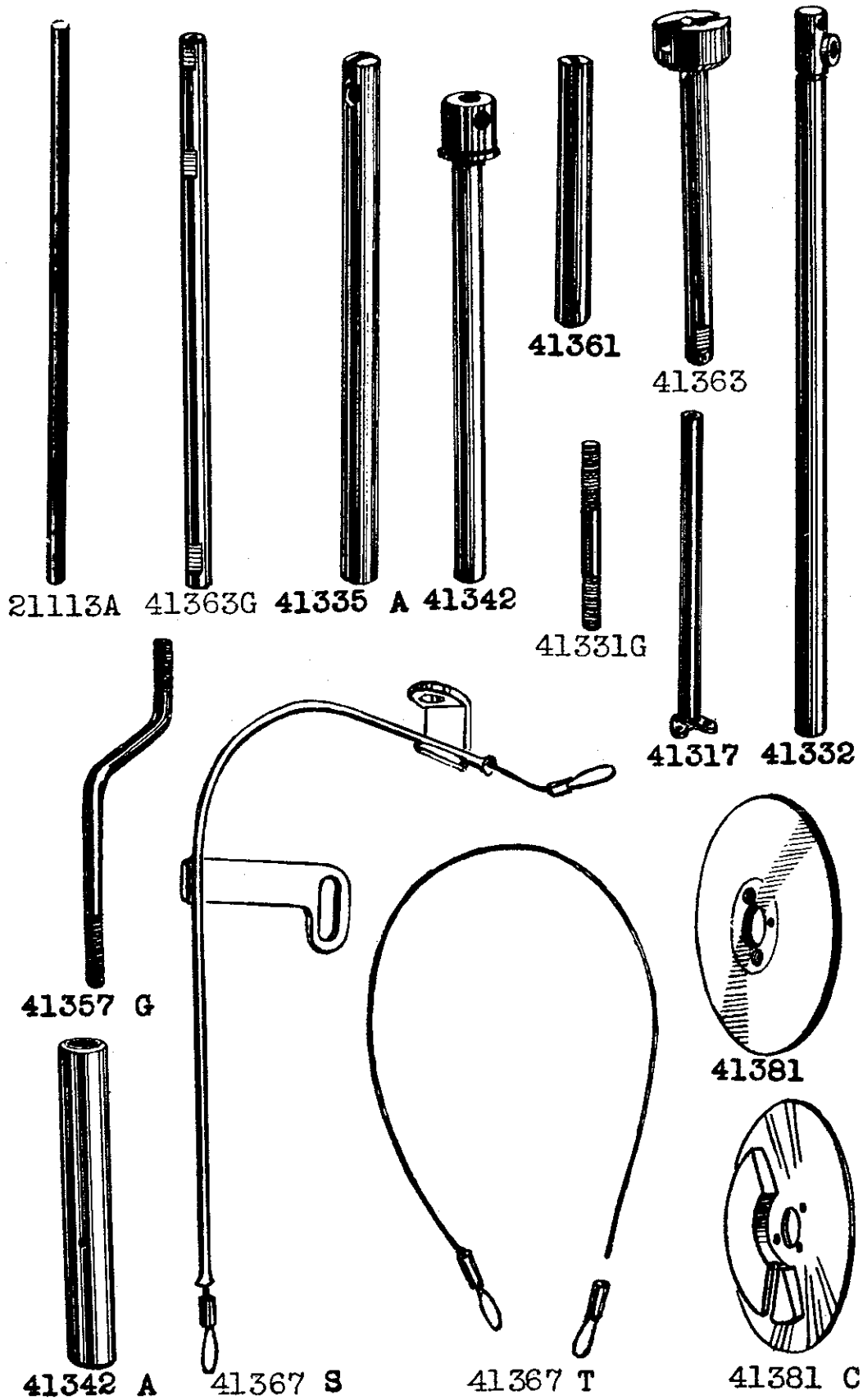

Plate 10 - One-Half Size

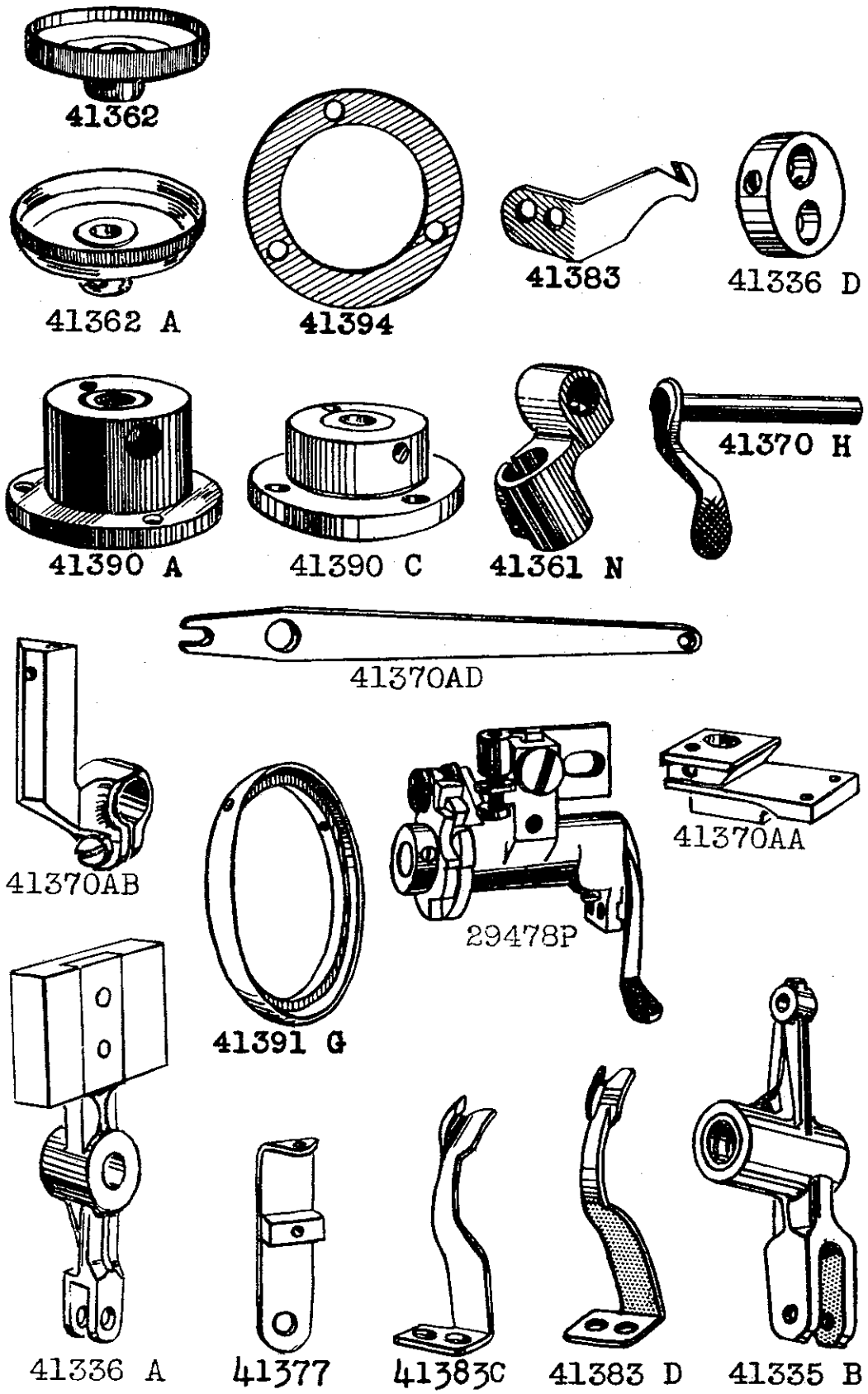
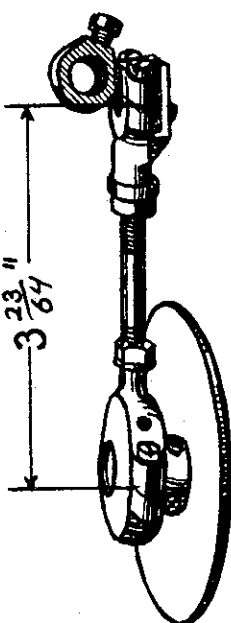
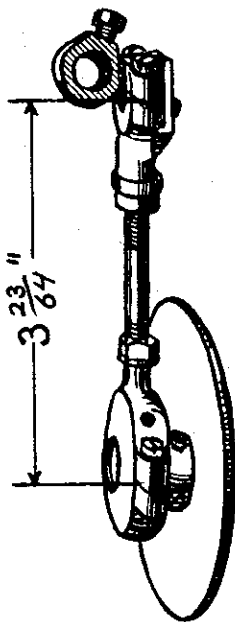

Plate 11 - One-Half Size



29478BB



29478 G

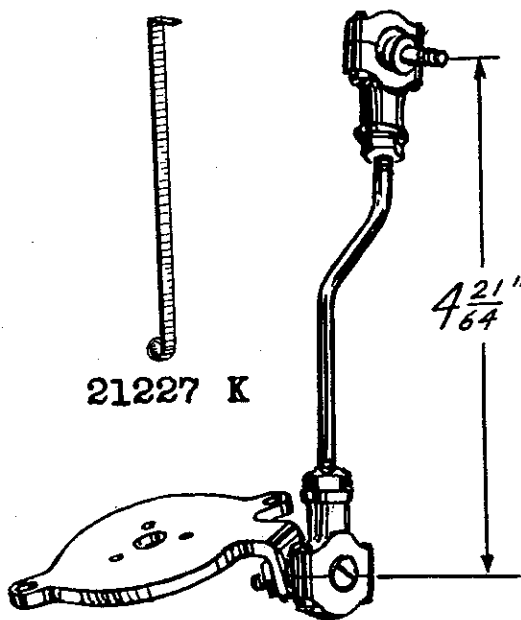

21227 K

29478 AU

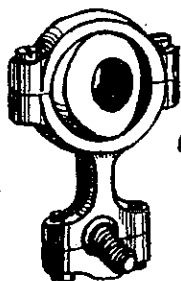

29126AL

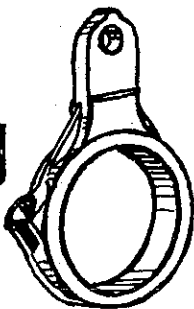

41336 B

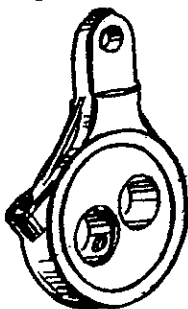

29133 G

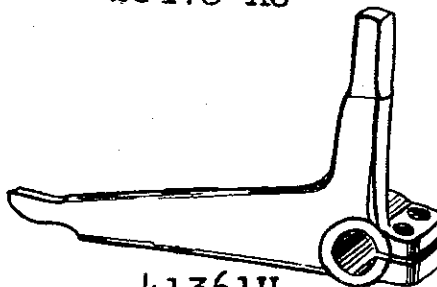

41361U

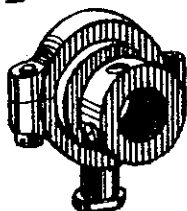

29126 AM

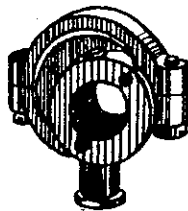

29126 AN

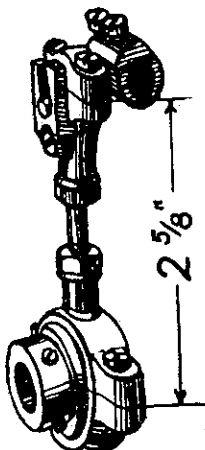

29478 F

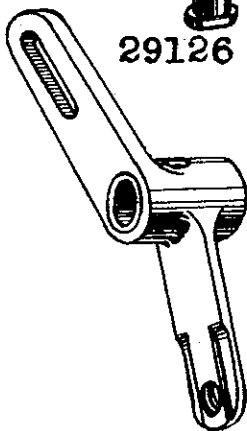

41355 A

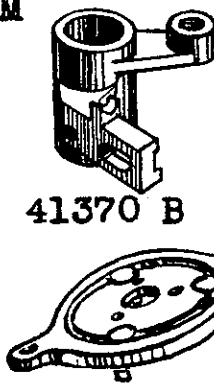

41370 B

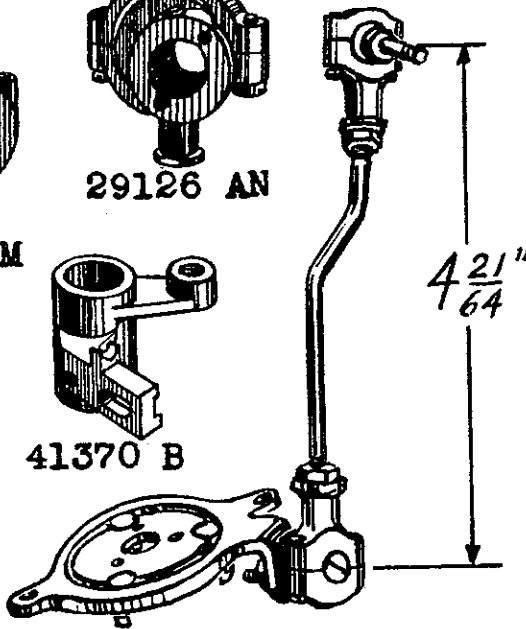

29478 BM

Plate 12 - One-Half Size

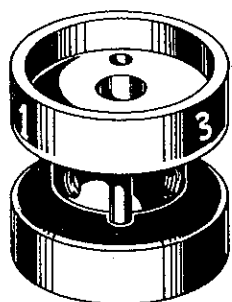

41358M

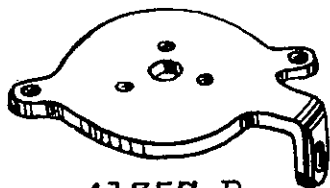

41357 B

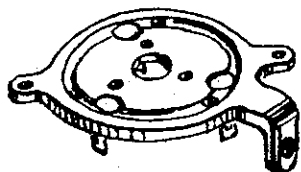

41357 C

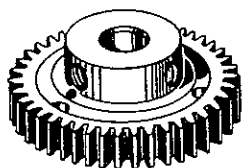

41365B

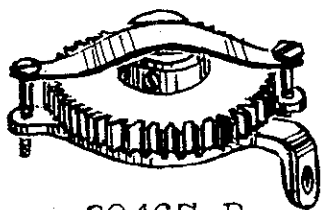

29467 B

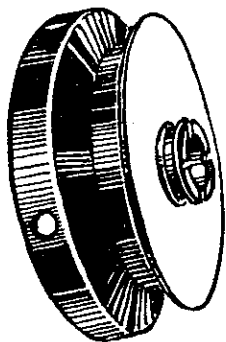

41321 B

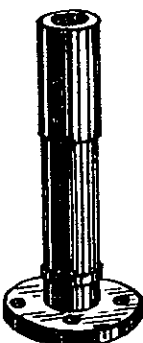

41364

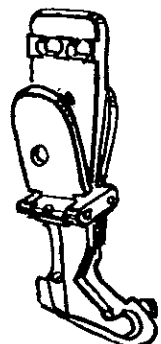

29450 M

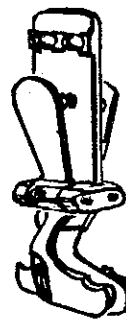

29450 P

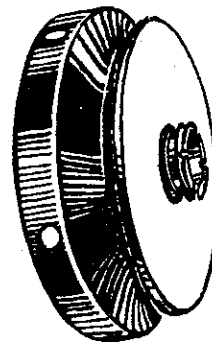

39121

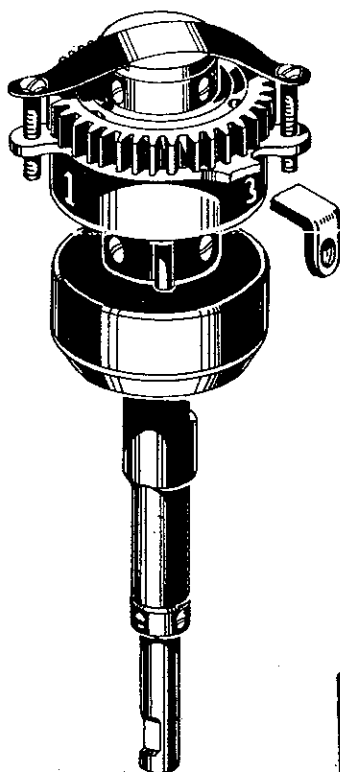

29478BP

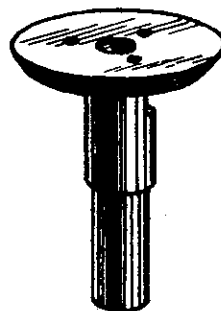

41364 G



41363 J



41363 A

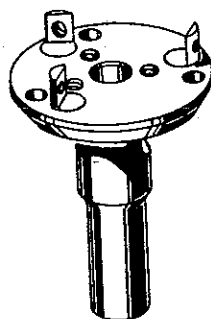

41364J

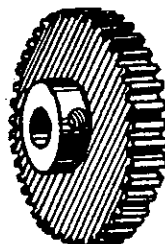

41365

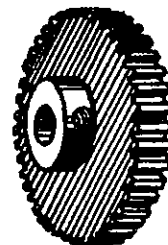

41365 A

Plate 13 - One-Half Size

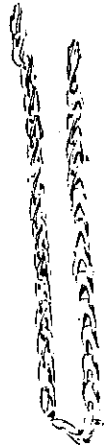

421 D
Specify Length

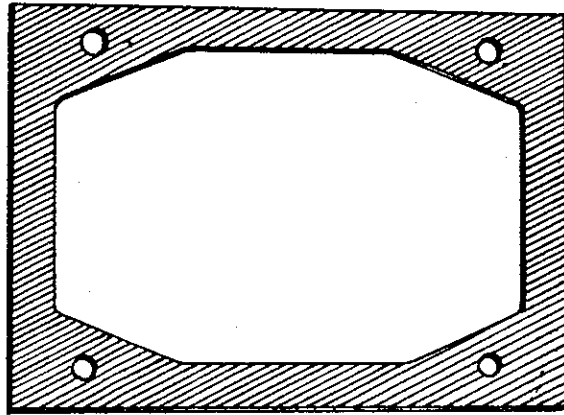

41394 C



21227 L

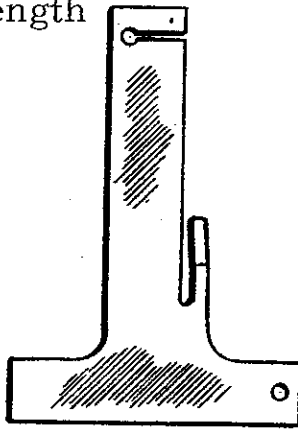

21225 D

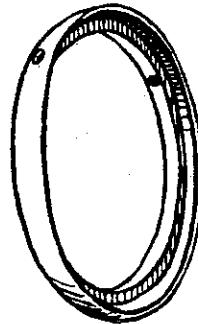

41391 H



660-240

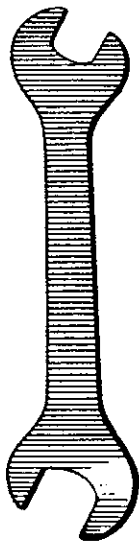

21388 R



21388 N



21388



21388 D



115

Plate 14 - One-Half Size



660-156

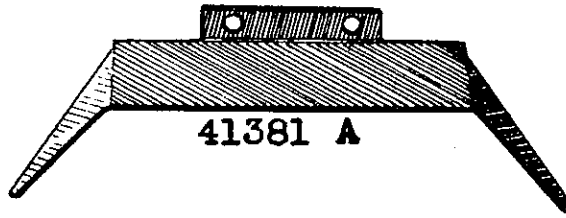

41381 A



423

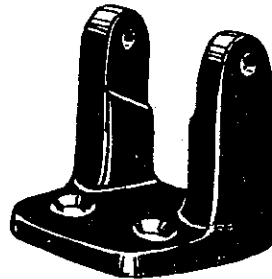

41375 K



21353 A



21207



9271



21227 M

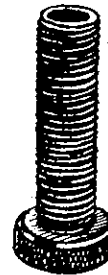

41375 U



424

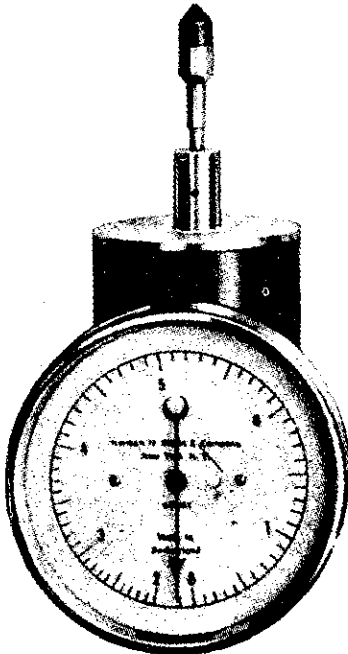

TA55



21197 F

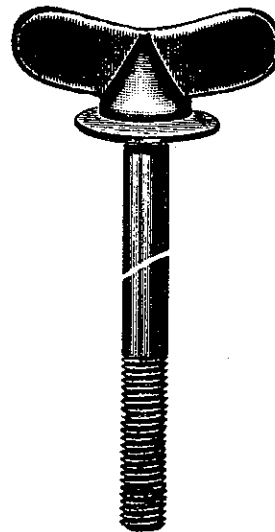

105
Specify
Measurement



21209C

Plate 15 - One-Fourth Size



41380 S



41375

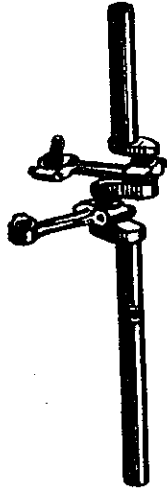

41322E



41380C



41380 P

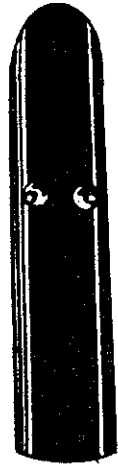

41380 N

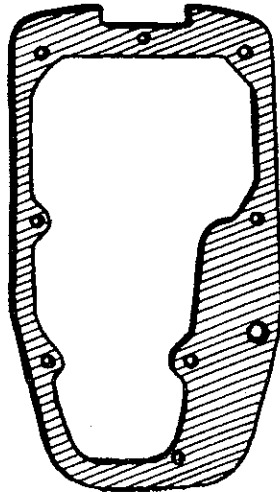

41394B



41375 J



41375 H



41381G



21662

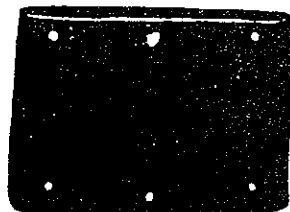

41380 H

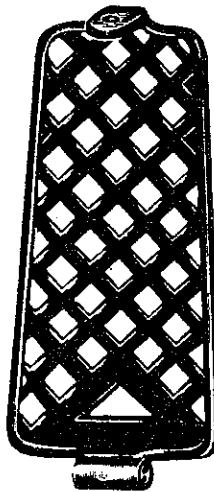

422

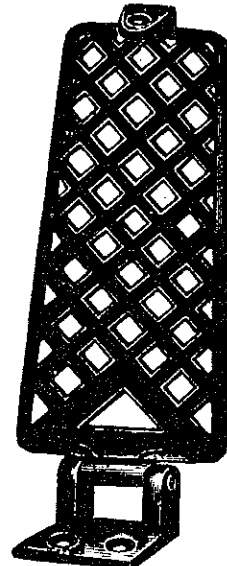

29402

Plate 16 - One-Fourth Size

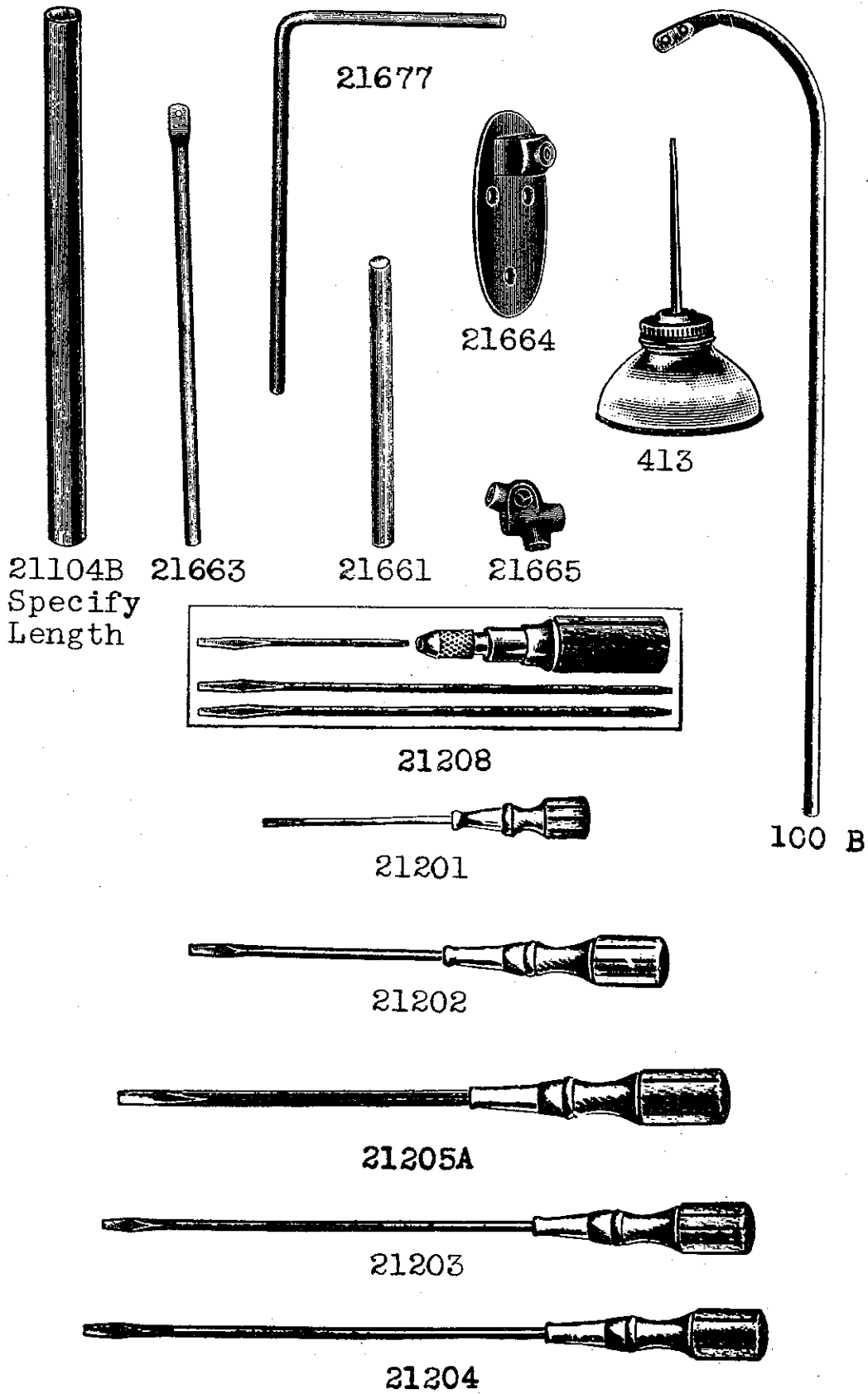
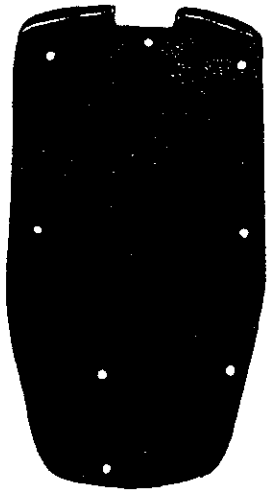
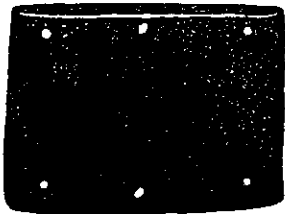

Plate 17 - One-Fourth Size



41380B



41380 J

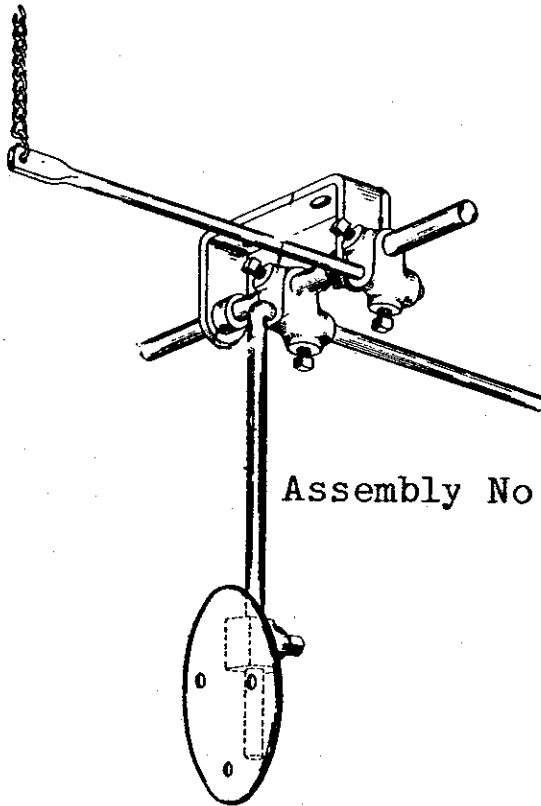

Assembly No. 21691A

One-Eighth Size

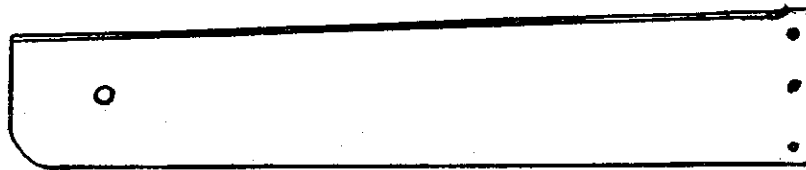

21197 G



21197 E



21197 D



K56697



21114A



21192F



69 S



21197 K



21388 AA

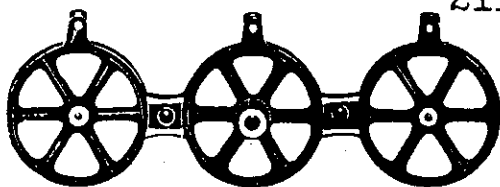

21130 A-3

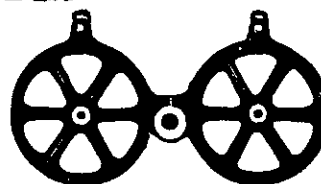

21130 A-2

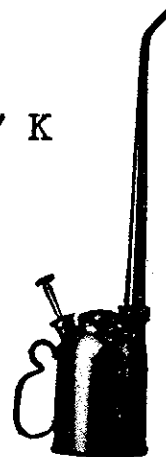

OI-19

LIST OF PARTS

Symbol to Order By	The figures in the last column refer only to the plates illustrating the parts and are not to be used in ordering. Prices furnished on application.	Plate No.
WA15 A 18	Stop Watch----- Nut, right thread, for spreader and back looper eccentric connecting rod; also for Nos. 41331 G, 41357 G -----	2 2
OI-19	Pressure Pump Oil Can, 1 1/2 pints capacity-----	17
PA19	Packing, for No. 41332 K, 41350 V-----	-
PL25	Plug -----	-
C41	Pivot Stud, for retractable fabric puller and chain cutting knife -----	2
50-216 Blk.	Dowel Pin, for oil distributing disc-----	8
TA55	Hand Tachometer, 300 to 12000 R. P. M. -----	14
57 WB	Needle Thread Auxiliary Tension Plate, for Styles 41300 A, 41300 B, 41300 C, 41300 D, 41300 E, 41300 F, 41300 G, 41300 H, 41300 J, 41300 T, 41300 U, 41300 W -----	5
57 WC	Needle Thread Auxiliary Tension Spring -----	3
57 WD	Needle Thread Auxiliary Tension Spring Stud -----	1
69 S	Spool Pin, 4 inches long, for thread stand-----	17
69 FD	Set Screw, square head, cup point, 5/16 inch diameter, 18 threads to inch, 5/8 inch long, for Nos. 21663, 21664, 21665 -----	2
75	Screw, for cast iron top cover -----	1
77	Set Screw, for needle bar link pin; also for Nos. 41336 C, 41343 C-----	1
79	Screw, for crank shaft bearing housing -----	1
HA81	Spot Screw, for front feed cup pivot shaft bracket-----	1
87 U	Screw, for frame looper thread eyelet on Styles 41300 A, 41300 B, 41300 E, 41300 F, 41300 G, 41300 T, 41300 U, 41300 W; also for No. 41358 D, 41258 A, 41376 A-----	1
88	Screw, for looper lever shaft and stitch regulator shaft collar; also for Nos. 21113 B, 41362, 41362 A, 41335 A-----	1
89	Screw, for front fabric uncurler ratchet -----	1
90	Screw, for needle thread and looper thread eyelet on Styles 41300 M, 41300 N, 41300 P, 41300 Q, 41300 R, 41300 S, 41300 T, 41300 V; also for Nos. 41376 B, 41343 B, 41370 AF-----	1
93	Screw, for wale guide blade on Style 41300 E; also for No. 41370 AB -----	1
93 A	Screw, for oil spray deflector plate -----	1
94	Screw, for stitch tongue support, aslo for No. 41370 BC -----	1
95	Lock Screw, for front feed cup adjusting stud; also for No. 41361 J-----	1
97 A	Bearing Screw, front, for feed eccentric assembly; also for Nos. 41332 F, 41342 F-----	2
98	Set Screw, for pulley; also for Nos. 2339 F, 9271--	1
100 B	Thread Stand Wire, 16 inches long (screw No. 22650 CB-4) -----	16

From the library of: Diamond Needle Corp

LIST OF PARTS

Symbol to Order By	The figures in the last column refer only to the plates illustrating the parts and are not to be used in ordering. Prices furnished on application.	Plate No.
105-1 1/2	Machine Mounting Screw, for pedestal installation -----	14
105-4	Machine Mounting Screw, 4 inches long -----	14
109	Tension Disc -----	5
115	Wrench, single end, light duty, for connecting rod nut, 3/8 inch opening -----	13
134	Stud, for pivoted blade on wale guide assembly No. 21197 Q -----	2
138	Screw, for fabric pulling plate -----	1
258 A	Nut, for feed eccentric assembly -----	2
269	Nut, left thread, for spreader and back looper eccentric connecting rod; also for Nos. 41331 G, 41357 G -----	2
318	Attaching Screw, for fabric uncurler support mounting bracket on Styles 41300 F, H, M, N, P, R, T, U, V, W -----	1
413	Oil Can, complete -----	16
421 D-10	Feed Cup Separating Chain, upper, 10 inches long ---	13
421 D-18	Uncurler Shifting Device Chain, 18 inches long ----	13
421 D-34	Feed Cup Separating Chain, lower, 34 inches long ----	13
422	Feed Cup Separating Treadle -----	15
423	Feed Cup Separating Treadle Base -----	14
424	Feed Cup Separating Treadle Pin (screw No. 22813) -----	14
426	Spring, for knee press -----	8
454 A	Washer, for stitch regulator adjusting nut, also for No. 29485 D -----	2
531	Set Screw, for feed cup driving gear -----	1
562	Lock Screw, for machine mounting screw -----	2
605 A	Attaching Screw, for needle holder; also for Nos. 41381, 41381 C -----	1
660-92	Washer, leather, 3/16 inch hole, for top of glass tube in oil level guage -----	2
660-93	Washer, leather, 1/4 inch hole, for bottom of glass tube in oil level gauge -----	2
660-128	Wood Screw Eyelet -----	3
660-142	Feed Cup Separating Lever Cotter Pin -----	4
660-156	Machine Mounting Screw Felt Washer -----	14
660-204	Pulley Oil Seal Ring -----	3
660-210	Snap Washer, for No. 29485 D -----	8
660-240	Thread Tweezers -----	13
660-264	"S" Hook for Nos. 421 D-10, 421 D-18, 421 D-34 --	8
666-80	Glass Tube, for oil level gauge -----	3
668-25	Steel Insert, for needle and looper thread tension eyelet assemblies -----	5
668-26	Steel Insert, for thread ratio control frame eyelet -----	5
668-28	Steel Insert Locking Ring, for needle and looper thread tension eyelet assemblies; also for No. 41378 -----	2
907	Nut, for oil distributing plate screw 22516 A -----	2

LIST OF PARTS

Symbol to Order By	The figures in the last column refer only to the plates illustrating the parts and are not to be used in ordering. Prices furnished on application.	Plate No.
1286 A	Looper Lever Link Pin (set screw No. 22768) -----	3
2339 F	Wale Guide Rod Collar, for assemblies Nos. 21197 P, 21197 Q (Screw No. 98)-----	4
6258	Spring, for fabric uncurler support sliding arm, on No. 29478 R, on Styles 41300 P, 41300 Q, 41300 R, 41300 S, 41300 T, 41300 U, 41300 V, 41300 W -----	3
6956 C	Spring, for machine mounting screw locking pin ---	3
6990	Spring, for fabric uncurler support sliding arm adjustment stud locking ball on No. 29478 R for Styles 41300 P, 41300 Q, 41300 R, 41300 S, 41300 T, 41300 U, 41300 V, 41300 W -----	3
9271	Collar, for knee press bracket shaft (screw No. 98)-----	14
12538	Nut, for feed clutch driving lever ball joint; also for Nos. 22888, 41367 S-----	2
12964 C	Locking Ball, for fabric uncurler support sliding arm adjustment stud on No. 29478 R for Styles 41300 P, 41300 Q, 41300 R, 41300 S, 41300 T, 41300 U, 41300 V, 41300 W-----	2
21104 B-9	Thread Stand Rod, 9 inches long (screw No. 22651 CD-5, 22650 CE-6) -----	16
21113 A	Thread Stand Wire Extension (screw No. 22650 CB-4) -----	9
21113 B	Thread Stand Wire Coupling (screw No. 88) -----	4
21114 A	Thread Stand Base, one No. 22651 CD-5-----	17
21130 A-2	Thread Stand Seat, two spools (set screw Nos. 22650 CB-4, 22650 CE-6) -----	17
21130 A-3	Thread Stand Seat, three spools (set screw Nos. 22650 CB-4, 22650 CE-6) -----	17
21192 F	Wale Guide Base, lower, for assemblies Nos. 21197 P, 21197 Q (screw No. 22591)-----	17
21197 D	Wale Guide Stationary Blade, for assembly No. 21197 Q (screw No. 93) -----	17
21197 E	Wale Guide Pivoted Blade, for assembly No. 21197 Q; (stud No. 134) -----	17
21197 F	Wale Guide Pivoted Blade Lifter for No. 21197 Q --	14
21197 G	Wale Guide Blade, for assembly No. 21197 P (screw No. 93) -----	17
21197 K	Wale Guide Rod, for assemblies Nos. 21197 P, 21197 Q -----	17
21197 P	Wale Guide Assembly, for Style 41300 E; one each Nos. 98, 2339 F, 21192 F, 21197 G, 21197 K, K56697; three No. 93 -----	-
21197 Q	Wale Guide Assembly, with adjustable blade, for Style 41300 E; one each Nos. 98, 134, 2339 F, 21192 F, 21197 D, 21197 E, 21197 F, 21197 K, K56697; two No. 93 -----	-
21201	Screw Driver, 9/64 inch round blade, length overall 7 3/8 inches -----	16
21202	Screw Driver, 3/16 inch round blade, length overall 9 3/8 inches -----	16

From the library of: Diamond Needle Corp

LIST OF PARTS

Symbol to Order By	The figures in the last column refer only to the plates illustrating the parts and are not to be used in ordering. Prices furnished on application.	Plate No.
21203	Screw Driver, 3/16 inch round blade, length overall 11 3/8 inches -----	16
21204	Screw Driver, 7/32 inch round blade, length overall 15 inches -----	16
21205 A	Screw Driver, 3/8 inch round blade, length overall 14 5/8 inches -----	16
21207	Screw Driver, 7/64 inch round blade, length overall 2 1/2 inches -----	14
21208	Screw Driver Set, 3 detachable blades -----	16
21209 C	Off-Set Screw Driver, for needle guard screws ----	14
21225 D	Front Looper Timing Gauge, for rocking motion ----	13
21227 K	Gauge, for locating needle shank with respect to rear feed cup shaft -----	11
21227 L	Gauge, for setting height of feed cup with respect to needle bar -----	13
21227 M	Gauge, for maximum space between feed cups ----	14
21227 BD	Gauge, for setting height of needle holder -----	-
21227 NA	Gauge, for setting height of spreader No. 41340 A or back looper No. 41309 A at extreme high position -----	3
21227 QA	Gauge, for setting needle and front looper with respect to each other on machines equipped with looper No. 41308 B -----	2
21227 WE	Set of Gauges, packed in a leather case; one each Nos. 21225 D, 21227 K, 21227 L, 21227 M, 21227 BD, 21227 NA, 21227 QA, 21227 XA -----	-
21227 XA	Adjusting Gauge Case -----	-
21260	Emery Cord, 3/64 inch diameter, grade No. 120, fifty yard spool -----	-
21260 A	Emery Cord, 3/64 inch diameter, grade No. 150, fifty yard spool -----	-
21260 B	Emery Cord, 1/32 inch diameter, grade No. 180, fifty yard spool -----	-
21260 C	Emery Cord, .030 inch diameter, grade No. 200, fifty yard spool -----	-
21260 D	Emery Tape, 3/32 inch wide, grade No. 180, fifty yard spool -----	-
21260 E	Emery Cord, .018 inch diameter, grade No. 200, fifty yard spool -----	-
21261	Leather Belt, flat, 1 inch wide, 63 inches long, includes belt fastener No. 21350 -----	-
21262 E-56	Leather Belt, round, 1/4 inch diameter, 56 inches long, includes wire belt hook No. 21351 B -----	-
21350	Belt Fastener, malleable iron, for 1 inch flat belt -----	5
21351 B	Belt Hook, wire, for 1/4 inch round belt -----	5
21353 A	Steel Washer, for machine mounting screw -----	14
21388	Wrench, single end, heavy duty, 3/8 inch opening -----	13
21388 D	Alligator Wrench, for connecting rods -----	13
21388 N	Wrench, double end, 3/16 and 5/16 inch opening -----	13

LIST OF PARTS

Symbol to Order By	The figures in the last column refer only to the plates illustrating the parts and are not to be used in ordering. Prices furnished on application.	Plate No.
21388 R	Wrench, double end, 3/8 and 1/2 inch openings ----	13
21388 AA	Wrench, for crankshaft bearing housing-----	17
21394	Utility Grinder, including emery wheel, 5 inch diameter, 1/4 inch face, round belt drive, recommended speed 3000 R. P. M. -----	-
21394 G	Emery Wheel, 5 inch diameter, 1/4 inch face, 3/8 inch hole, grade "M" emery 60-----	-
21394 H	Emery Wheel, 5 inch diameter, 1/2 inch face, 3/8 inch hole, grade "M" emery 60-----	-
21394 K	Utility Grinder, including emery wheel, 5 inch diameter, 1/2 inch face, round belt drive, recommended speed 3000 R. P. M. -----	-
21661	Knee Press Bracket Shaft -----	16
21662	Knee Press Bracket -----	15
21663	Knee Press Rod, 9 1/8 inches long (screw No. 69 FD) -----	16
21664	Knee Press Plate (screw No. 69 FD) -----	16
21665	Knee Press Rod Connection (screw No. 69 FD) ----	16
21677	Knee Press Plate Rod-----	16
21691 A	Knee Press Assembly; one each Nos. 421 D-18, 21661, 21662, 21663, 21664, 21677; two each Nos. 9271, 21665 (specify component parts when ordering) -----	17
21756 G	Fabric Uncurler Support Sliding Arm Operating Stud, on No. 29478 R, for Styles 41300 P, 41300 Q, 41300 R, 41300 S, 41300 T, 41300 U, 41300 V, 41300 W -----	2
22504 A	Screw, for fabric uncurler ratchet pawl -----	2
22516 A	Screw, for front feed cup shaft, lower section; also for Nos. 41363 A, 41380, 41380 H, 41380 J, 41381 A -----	1
22517	Clamp Screw, for front feed cup pivot shaft bracket; also for No. 41361 U-----	1
22533 A	Set Screw, for rear feed cup shaft bushing -----	2
22537	Screw, for upper front feed cup shaft bushing-----	1
22539 D	Plug Screw, headless, 7/8 inch diameter, for left side of bed-----	1
22539 E	Plug Screw, headless, 9/16 inch diameter, for right, left and rear of bed; also for No. 41335 A---	1
22547 A	Screw, for looper needle guard -----	2
22548	Screw, for stitch tongue support upper bracket; also for No. 41370 B-----	1
22557	Stud, for fabric uncurler support sliding arm operating lever on Styles 41300 F, H, M, N, P, Q, R, S, T, U, V, W -----	2
22559 D	Bearing Screw, for looper lever connecting rod assembly; also for needle bar connecting rod ----	1
22560 A	Set Screw, for front feed cup driving gear No. 41360 -----	1
22560 B	Set Screw, for clutch driving eccentric bearing; also for Nos. 29126 AM, 29126 AN-----	1
22562	Screw, for back looper and spreader; also for No. 41370 AF on No. 29478 R -----	1

LIST OF PARTS

Symbol to Order By	The figures in the last column refer only to the plates illustrating the parts and are not to be used in ordering. Prices furnished on application.	Plate No.
22565	Screw, for front looper -----	1
22565 C	Screw, for pulley rim-----	1
22568	Adjusting Screw, for fabric uncurler mounting bracket on Styles 41300 A, 41300 B, 41300 C, 41300 D, 41300 G, 41300 J, 41300 K, 41300 L, 41300 Q, 41300 S-----	2
22570 A	Screw, for stitch tongue support intermediate bracket; also for Nos. 29450 L, 29450 M, 29450 P, 41335 A, 41367 S, 41383, 41383 C, 41383 D, 41383 E -----	1
22572	Screw, for fabric uncurler support sliding arm stop, on No. 29478 R, for Styles 41300 P, 41300 Q, 41300 R, 41300 S, 41300 T, 41300 U, 41300 V, 41300 W -----	1
22584	Set Screw, for needle bar; also for No. 41375 F ---	1
22585	Clamp Screw, for Nos. 41370 AC, 41367 L-----	1
22585 A	Screw, for frame thread eyelet on Styles 41300 C, 41300 D, 41300 H, 41300 J-----	1
22585 C	Screw, for stationary needle guard-----	1
22587 E	Bearing Screw, rear, for feed eccentric assembly; also for Nos. 29126 AM, 29126 AN-----	2
22591	Set Screw, for front feed cup pivot shaft bracket, also No. 21192 F-----	1
22596 D	Clamp Screw, for No. 41039 A -----	3
22597 A	Set Screw, for feed clutch housing-----	1
22597 B	Spot Screw, for feed clutch housing on machines equipped with constant wedge angle clutch-----	1
22597 E	Screw, for attaching upper bracket of retractable fabric puller and chain cutting knife -----	1
22650 CB-4	Screw, for No. 100 B, also No. 21113 A-----	1
22650 CE-6	Screw, for 21109 B-9-----	1
22651 CD-5	Screw, for No. 21114 A-----	1
22707 A	Screw, for feed clutch compensator spring-----	1
22729 C	Screw, for 41355 K-----	3
22733 B	Plug Screw, fillister head, for needle bar adjusting screw hole (gasket No. 41394 A, washer No. 41394 G)-----	1
22738 B	Set Screw, for uncurler hinge pin -----	1
22743	Screw, for rear feed cup shaft collar; also for Nos. 41332 P, 41332 S, 41363, 41363 A, 41370 AY-----	1
22747	Screw, for ball joint forks; also for Nos. 41258 B, 41258 E, 41358 N, 41358 P-----	1
22764	Screw, for uncurler support sliding arm adjustment stud locking ball on Styles 41300 F, H, M, N, P, Q, R, S, T, U, V, W-----	1
22764 A	Set Screw, for front feed cup adjusting eccentric collar; also for Nos. 29126 AL, 29126 AM, 29126 AN, 41335 A, 41365 A, 41365 B-----	1
22768	Set Screw, for looper lever link pin -----	1
22798 A	Screw, for stitch tongue and needle-----	1
22813	Set Screw, for feed cup separating treadle pin; also for No. K56697 -----	1

From the library of: Diamond Needle Corp

LIST OF PARTS

Symbol to Order By	The figures in the last column refer only to the plates illustrating the parts and are not to be used in ordering. Prices furnished on application.	Plate No.
22830	Screw, for fabric uncurler support bracket-----	1
22845 G	Screw, for No. 41370 BD, on No. 29478 BV -----	1
22849	Screw, for feed cup separating mechanism cover --	2
22852	Screw, for oscillating counterweight-----	2
22872	Screw, for thread ratio control frame -----	1
22888	Screw, for looper lever on machines equipped with oscillating counterweight -----	2
22894 E	Set Screw, for No. 41336 D-----	1
22894 H	Spot Screw, for No. 41336 D-----	2
28606-1/2	Powdered Oil Stone, 1/2 lb. package -----	
28606-1	Powdered Oil Stone, 1 lb. package-----	
‡29126 AL	Feed Eccentric Assembly; includes eccentric No. 41357 A (set screw No. 22560 B, spot screw No. 22764 A, bearing screw, rear, No. 22587 E, Bearing screw, front, No. 97 A, nut No. 258 A, washer No. 35746 A, shim No. 41355 U)-----	11
‡29126 AM	Spreader and Back Looper Eccentric Assembly; includes eccentric No. 41341 (set screw No. 22560 B, spot screw No. 22764 A, bearing screw No. 22587 E)-----	11
‡29126 AN	Looper Rocking Motion Eccentric Assembly; includes eccentric No. 41331 (set screw No. 22560 B, spot screw No. 22764 A, bearing screw No. 22587 E)-----	11
29133 G	Oscillating Counterweight Eccentric Assembly, for Styles 41300 E, 41300 F, 41300 G, 41300 H, 41300 J, 41300 M, 41300 N, 41300 P, 41300 Q, 41300 R, 41300 S, 41300 T, 41300 U, 41300 V, 41300 W; one each Nos. 41336 B, 41336 D-----	11
29402	Feed Cup Separating Treadle Assembly; one each Nos. 422, 423, 424, 22813-----	15
29450 L	Fabric Uncurler Assembly, for Styles 41300 K, L, M, N, R, S (attaching screw No. 22570 A, guide pin No. 41274, guide pin nut No. 41274 A---	-
‡29450 M	Fabric Uncurler Assembly, for Styles 41300 A, B, C, D, F, G, H, J, P, Q, (attaching screw No. 22570 A, uncurler set screws No. 22738 B, guide pin No. 41274, guide pin nut No. 41274 A, spring No. 41370 C)-----	12
29450 P	Fabric Uncurler Assembly, on Styles 41300 T, 41300 U, 41300 V, 41300 W, (attaching screw No. 22570 A, uncurler set screws No. 22738 B, guide pin No. 41274, guide pin nut No. 41274 A, spring No. 41370 C)-----	12
29467 B	Feed Cup Driving Gear Assembly, for adding clutch compensator feature to old style clutches; one each Nos. 41258 E, 41357 B, 41358 A, 41358 B, 41365 A; two each No. 22707 A; three each Nos. 87 U, 22747; six each Nos. 41358 C, 41358 D -----	12

‡ See Page 7

LIST OF PARTS

Symbol to Order By	The figures in the last column refer only to the plates illustrating the parts and are not to be used in ordering. Prices furnished on application.	Plates No.
29478 F	Spreader and Back Looper Eccentric Connecting Rod Assembly; one each Nos. 29126 AM, 18, 269, 22747, 41037 A, 41342 F, 41342 H. Assembly is set to gauge before shipment. The approximate distance between centers is 2 5/8 inches-----	11
29478 G	Looper Rocking Motion Eccentric Connecting Rod Assembly; one each Nos. 29126 AN, 18, 50-216 Blk., 269, 22747, 41331 G, 41332 F, 41332 H, 41381; two No. 605 A. Assembly is set to gauge before shipment. The approximate distance between centers is 3 23/64 inches-----	11
29478 P	Fabric Uncurler Mounting Bracket Assembly; one each Nos. 22504 A, 22548, 22568, 41370 A, 41370 B, 41370 G, 41370 H, 41370 N, 41370 P, 41370 U, 41370 V-----	10
29478 AU	Feed Clutch Driving Lever Connecting Rod Assembly, for machines equipped with flat surface clutch blocks; one each Nos. 18, 269, 12538, 35746 A, 41355 K, 41357 B, 41357 G, 41357 J. Assembly is set to gauge before shipment. The approximate distance between centers is 4 21/64 inches-----	11
29478 BB	Looper Rocking Motion Eccentric Connecting Rod Assembly, for machines equipped with oscillating counterweight; one each Nos. 29126 AN, 18, 50-216 Blk., 269, 22747, 41331 G, 41332 F, 41332 H, 41381 C; two No. 605 A. Assembly is set to gauge before shipment. The approximate distance between centers is 3 23/64 inches-----	11
29478 BM	Feed Clutch Driving Lever Connecting Rod Assembly, for machines equipped with constant wedge angle clutch; one each Nos. 18, 269, 12538, 35746 A, 41355 K, 41355 U, 41357 C, 41357 G, 41357 J. Assembly is set to gauge before shipment. The approximate distance between centers is 4 21/64 inches-----	11
29478 BN	Constant Wedge Angle Feed Clutch Assembly; one each Nos. 29478 BM, 41358 B, 41358 M, 41358 N, 41358 P, 41358 R, 41358 U, 41363 J, 41363 U, 41364 J, 41365 B; two each Nos. 22707 A, 41350 W; three No. 22597 B; six each Nos. 22747, 41258, 41358 Q, 41358 S, 41358 T---	11
29478 BP	Feed Clutch Assembly, to convert machines with old style clutches to constant wedge angle clutch; one each Nos. 41357 C, 41358 B, 41358 M, 41358 N, 41358 P, 41358 R, 41358 U, 41363 J, 41363 U, 41364 J, 41365 B; two each Nos. 22707 A, 41350 W; three No. 22597 B; six each Nos. 22747, 41258, 41358 Q, 41358 S, 41358 T---	12

LIST OF PARTS

Symbol to Order By	The figures in the last column refer only to the plates illustrating the parts and are not to be used in ordering. Prices furnished on application.	Plate No.
29478 BV	Fabric Uncurler Mounting Bracket Assembly, for knee controlled adjustment of uncurler; one each Nos. 90, 22504 A, 22557, 22743, 22764, 22845 G, 41370 A, 41370 H, 41370 N, 41370 P, 41370 U, 41370 V, 41370 AD, 41370 AF, 41370 AT, 41370 AV, 41370 AW, 41370 AX, 41370 AY, 41370 BC, 41370 BD; two No. 94, 41071 G, for 41300 F, 41300 H, 41300 M, 41300 N, 41300 P, 41300 Q, 41300 R, 41300 S, 41300 T, 41300 U, 41300 V, 41300 W-----	-
29485 D	Thread Ratio Control Assembly, for three end stitch on Styles 41300 M, N, P, Q, R, S, T, V, W; one each Nos. 660-210, 41378 V, 41378 X; No. 454 A -----	-
29485 E	Thread Ratio Control, for three end stitch on Styles 41300 M, 41300 N, 41300 P, 41300 Q, 41300 R, 41300 S, 41300 T, 41300 V, 41300 W; one each Nos. 41376 G, 41378, 41378 J, 43266, 51292 C, 51292 F-1; two each Nos. 90, 41378 K, six No. 109 -----	-
33174 B 35549	Set Screw, for looper and spreader bars ----- Tension Spring, .026 inch diameter wire for Styles 41300 A, 41300 B, 41300 C, 41300 D, 41300 E, 41300 F, 41300 G, 41300 H, 41300 J, 41300 T, 41300 U, 41300 W-----	1 3
35746 A	Feed Clutch Driving Lever Ball Joint Washer; also for No. 29126 AL -----	2
39121	Pulley, grooved for round belt (spot screw No. 96, set screw No. 98)-----	12
39147 D	Looper Lever Shaft and Stitch Regulator Lever Shaft Collar (screw No. 88)-----	4
39157 K	Regulating Nut, for thread ratio control tension sleeve on Styles 41300 M, 41300 N, 41300 P, 41300 Q, 41300 R, 41300 S, 41300 T, 41300 V, 41300 W -----	2
39193 B	Oil Level Gauge Base, for No. 41393 -----	3
41037 A	Spreader and Back Looper Eccentric Connecting Rod (nut, right thread No. 18, nut, left thread No. 269)-----	4
41039 A	Front Looper Bar Connection Collar (screw No. 22596 D)-----	4
41071 G	Nut, for lower cable attaching screw on retractable fabric puller and chain cutting knife, also for No. 41370 AX -----	2
41258	Feed Clutch Roller -----	4
41258 A	Feed Clutch Roller Torsion Spring, for machines equipped with flat surface clutch blocks (screw No. 87 U)-----	3
41258 B	Feed Clutch Triangular Block, lower, with flat surface (screw No. 22747)-----	7
41258 E	Feed Clutch Triangular Block, upper, with flat surface (screw No. 22747)-----	7

From the library of: Diamond Needle Corp

LIST OF PARTS

Symbol to Order By	The figures in the last column refer only to the plates illustrating the parts and are not to be used in ordering. Prices furnished on application.	Plate No.
41274	Fabric Uncurler Guide Pin -----	2
41274 A	Fabric Uncurler Guide Pin Nut-----	2
41298-5	Shim, .005 inch thick, for increasing height of stitch tongue -----	5
41308 B	Looper, front (screw No. 22565) -----	6
41309 A	Looper, rear, for Styles 41300 C, 41300 D, 41300 H, 41300 J, 41300 M, 41300 N, 41300 P, 41300 Q, 41300 R, 41300 S, 41300 T, 41300 V, 41300 W; (screw No. 22562) -----	6
41310	Looper Needle Guard (screw No. 22547 A) -----	6
41317	Needle Bar (set screw No. 22584) -----	9
41318 A	Needle Holder (attaching screw No. 605 A, needle set screw No. 22798 A) -----	6
41321 B	Pulley, grooved for No. 1 "V" belt, taupe finish, (set screw No. 98)-----	12
41321 C	Pulley, grooved for round belt taupe finish (set screw No. 98)-----	-
‡41322 E	Crankshaft Assembly; includes crankshaft No. 41322 D -----	15
41325 D	Stationary Needle Guard, with .055 inch step, for use with stitch tongue support No.41366 C-----	6
41325 E	Stationary Needle Guard, with .040 inch step, for use with stitch tongue support No. 41366 D-----	6
41325 F	Stationary Needle Guard, with .065 inch step, for use with stitch tongue support No. 41366 E-----	6
-	Stationary Needle Guard Screw No. 22585 C -----	-
41331 G	Looper Rocking Motion Eccentric Connecting Rod (nut, right thread No. 18, nut, left thread No. 269)-----	9
41332	Front Looper Bar (set screw No. 33174 B) -----	9
41332 A	Front Bushing, for front looper bar -----	4
41332 B	Rear Bushing, for front looper bar -----	4
41332 C	Looper Bar Bushing Oil Seal Cap-----	2
‡41332 F	Looper Bar Ball Joint Assembly (bearing screw No. 97 A, looper bar screw No. 33174 B) -----	5
41332 H	Front Looper Bar Ball Joint Fork (screw No. 22747)-----	5
41332 J	Front Looper Bar Thrust Washer -----	2
41332 K	Looper Bar Bushing Oil Seal Cap, for Styles 41300 E, F, H, M, N, P, R, T, U, V, W -----	8
41332 L	Fibre Washer, for looper bar bushing oil seal cap -----	8
41332 P	Front Looper Bar Needle Thread Take-up Eyelet Holder (set screw No. 22743) -----	4
41332 S	Front Looper Bar Needle Thread Eyelet (screw No. 22743)-----	5
41335 A	Looper Lever Shaft and Stitch Regulator Shaft (screw No. 22764 A, plug screw No. 22539 E)-----	9
‡41335 B	Looper Lever, for machines equipped with oscillating counterweight (screw No. 22888)-----	10
41335 N	Looper Link -----	5
41335 P	Looper Lever Link Connection -----	5

‡ See Page 7

LIST OF PARTS

Symbol to Order By	The figures in the last column refer only to the plates illustrating the parts and are not to be used in ordering. Prices furnished on application.	Plate No.
‡41336 A	Oscillating Counterweight and Lever, complete ----	10
41336 B	Oscillating Counterweight Connection Bearing -----	11
41336 C	Oscillating Counterweight Connection Pin (screw No. 77) -----	3
41336 D	Oscillating Counterweight Eccentric (screws Nos. 22894 E, 22894 H) -----	10
41340 A	Spreader, for Styles 41300 A, 41300 B, 41300 E, 41300 F, 41300 G, 41300 K, 41300 L, 41300 T, 41300 U, 41300 W (screw No. 22562) -----	6
41342	Spreader and Back Looper Bar, includes screw No. 22562 (set screw No. 33174 B) -----	9
41342 A	Bushing, for spreader and back looper bar -----	9
‡41342 F	Spreader and Back Looper Connecting Rod Ball Joint Assembly (bearing screw No. 97 A) -----	5
41342 H	Spreader and Back Looper Connecting Rod Ball Joint Fork (screw No. 22747) -----	5
41343 B	Back Looper Bar and Spreader Bar Thread Eyelet for Styles 41300 F, 41300 G, 41300 H, 41300 J, 41300 M, 41300 N, 41300 P, 41300 Q, 41300 R, 41300 S, 41300 T, 41300 U, 41300 V, 41300 W (screw No. 77) -----	5
41343 C	Spreader Bar Eyelet Holder, for needle and looper thread eyelets in Styles 41300 F, 41300 G, 41300 H, 41300 J, 41300 M, 41300 N, 41300 P, 41300 Q, 41300 R, 41300 S, 41300 T, 41300 U, 41300 V, 41300 W (screw No. 77) -----	4
41345 G-4	Shim, .004 inch thick, for stationary needle guard -----	7
41345 G-5	Shim, .005 inch thick -----	7
41345 G-6	Shim, .006 inch thick -----	7
41345 G-7	Shim, .007 inch thick -----	7
41345 G-8	Shim, .008 inch thick -----	7
41345 G-9	Shim, .009 inch thick -----	7
41350	Needle Bar Link Assembly, includes one each Nos. 77, 41350 A, 41350 G, 41350 N-----	-
41350 A	Needle Bar Link (needle bar set screw No. 22584)-----	5
41350 G	Needle Bar Link Pin (screw No. 77) -----	4
41350 U	Needle Bar Bushing-----	4
41350 V	Needle Bar Bushing Oil Seal Cap -----	4
41350 W	Needle Bar Bushing Oil Seal Ring; also for lower feed clutch disc on machines equipped with constant wedge angle clutch-----	3
41350 X	Fibre washer, for needle bar bushing oil seal cap -----	8
41355	Stitch Regulator Adjusting Nut (washer No. 454 A)-----	4
‡41355 A	Stitch Regulator Lever, including bushings -----	11
‡41355 K	Stitch Regulator Ball Joint (screw No. 22729 C)-----	5
41355 U-004	Shim, .004 inch thick, for feed eccentric assembly upper bearing -----	2
41355 U-005	Shim, .005 inch thick -----	2
41355 U-006	Shim, .006 inch thick -----	2

‡ See Page 7

LIST OF PARTS

Symbol to Order By	The figures in the last column refer only to the plates illustrating the parts and are not to be used in ordering. Prices furnished on application.	Plate No.
41355 U-007	Shim, .007 inch thick -----	2
41355 U-008	Shim, .008 inch thick -----	2
41355 U-009	Shim, .009 inch thick -----	2
41357 B	Feed Clutch Driving Lever, for machines equipped with clutch compensator and flat surface clutch blocks-----	12
41357 C	Feed Clutch Driving Lever, for machines equipped with constant wedge angle clutch -----	12
41357 G	Feed Clutch Driving Lever Connecting Rod (nut, right thread No. 18, nut, left thread No. 269 -----	9
‡41357 J	Feed Clutch Driving Lever Ball Joint Assembly (nut No. 12538, washer No. 35746 A)-----	5
41357 N	Feed Clutch Housing Bushing, for machines equipped with flat surface clutch blocks -----	4
41358	Feed Clutch Spring Washer, for machines equipped with feed clutch roller torsion springs-----	2
41358 A	Feed Clutch Compensator Spring Locating Collar and Thrust Bearing, for machines equipped with flat surface clutch blocks-----	7
41358 B	Feed Clutch Compensator Spring (screw No. 22707 A)-----	7
41358 C	Feed Clutch Roller Compression Spring for machines equipped with flat surface clutch blocks-----	3
41358 D	Feed Clutch Roller Compression Spring Supporting Plate, for machines equipped with flat surface clutch blocks (screw No. 87 U)-----	7
41358 M	Feed Clutch Housing, for machines equipped with constant wedge angle clutch (set screw No. 22597 A, spot screw No. 22597 B)-----	12
41358 N	Feed Clutch Disc, upper, for machines equipped with constant wedge angle clutch (screw No. 22747)-----	7
41358 P	Feed Clutch Disc, lower, for machines equipped with constant wedge angle clutch (screw No. 22747)-----	7
41358 Q	Feed Clutch Roller Compression Spring, for machines equipped with constant wedge angle clutch -----	3
41358 R	Feed Clutch Compensator Spring Locating Collar and Thrust Bearing, for machines equipped with constant wedge angle clutch-----	7
41358 S	Feed Clutch Roller Spring Support Pin, for machines equipped with constant wedge angle clutch -----	7
41358 T	Feed Clutch Roller Spring Support Pin Spacing Washer, for machines equipped with constant wedge angle clutch-----	7
41358 U	Oil Seal Washer, for lower feed clutch disc on machines equipped with constant wedge angle clutch -----	2
41360	Front Feed Cup Adjusting Stud (lock screw No. 95)-----	4

‡ See Page 7

LIST OF PARTS

Symbol to Order By	The figures in the last column refer only to the plates illustrating the parts and are not to be used in ordering. Prices furnished on application.	Plate No.
41360 G	Front Feed Cup Adjusting Eccentric Collar (screw No. 22764 A) -----	4
41361	Front Feed Cup Pivot Shaft -----	9
41361 J	Front Feed Cup Pivot Shaft Bushing (screw No. 95)-----	4
41361 N	Front Feed Cup Pivot Shaft Bracket (spot screw No. HA81, set screw No. 22591, clamp screw No. 22517)-----	10
41361 U	Front Feed Cup Separating Lever (screw No. 22517)-----	11
41362	Feed Cup, width of feeding section 5/16 inch (screw No. 88) -----	10
41362 A	Feed Cup, width of feeding section 5/32 inch (screw No. 88) -----	10
41363	Front Feed Cup Shaft, lower section (screws No. 22516 A, 22743) -----	9
41363 A	Front Feed Cup Shaft, upper section (screws Nos. 22516 A, 22743) -----	12
41363 G	Feed Cup Shaft, rear, for machines equipped with flat surface clutch blocks-----	9
41363 J	Feed Cup Shaft, rear, for machines equipped with constant wedge angle clutch-----	12
41363 N	Front Feed Cup Shaft Floating Connector-----	4
41363 U	Rear Feed Cup Shaft Collar, for Styles 41300 A, B, C, D, G, J, K, L, Q, S, (screw No. 22743) -----	4
41364	Front Feed Cup Shaft Bearing-----	12
41364 G	Rear Feed Cup Shaft Bushing, for machines equipped with flat surface clutch blocks (set screw No. 22533 A)-----	12
41364 J	Rear Feed Cup Shaft Bushing, for machines equipped with constant wedge angle clutch (screw No. 22533 A)-----	12
41364 N	Upper Front Feed Cup Shaft Bushing (screw No. 22537)-----	4
41365	Feed Cup Driving Gear, front (screw No. 22560 A -	12
41365 A	Feed Cup Driving Gear, rear, for machines equipped with flat surface clutch (screw Nos. 531, 22764 A) -----	12
41365 B	Feed Cup Driving Gear, rear, for machines equipped with constant wedge angle clutch (screw Nos. 531, 22764 A) -----	12
41366 C	Stitch Tongue Support, marked "D", with .055 inch step, for use with needle guard No. 41325 D (screw No. 94) -----	6
41366 D	Stitch Tongue Support, marked "E", with .040 inch step, for use with needle guard No. 41325 E (screw No. 94) -----	6
41366 E	Stitch Tongue Support, marked "G", with .065 inch step, for use with needle guard No. 41325 F (screw No. 94) -----	6
-	Stitch Tongue Support Screw No. 94 -----	-
41366 G	Stitch Tongue Support Intermediate Bracket (screw No. 22570 A)-----	7

LIST OF PARTS

Symbol to Order By	The figures in the last column refer only to the plates illustrating the parts and are not to be used in ordering. Prices furnished on application.	Plate No.
41366 N	Stitch Tongue Support Upper Bracket (screw No. 22548)-----	7
41367 C	Tension Spring, for retractable fabric puller and chain cutting plate -----	3
41367 G	Knife, for retractable fabric puller and chain cutting knife -----	8
41367 J	Fabric Pulling Plate (screw No. 138) -----	8
41367 P	Retractable Fabric Puller and Chain Cutting Knife Assembly, for Styles 41300 K, L, M, N; one each Nos. C41, 138, 12538, 22597 E, 41367 C, 41367 G, 41367 J, 41367 R, 41367 S, 41380 P; two each Nos. 22570 A, 22849 -----	-
41367 R	Fabric Puller Arm -----	8
41367 S	Cable Assembly (bracket attaching screw, upper, No. 22597 E, lock nut, No. 12538, screw, lower, No. 22570 A)-----	9
41367 T	Cable, for retractable fabric puller and chain cutting knife assembly -----	9
41367 U	Retractable Fabric Puller and Chain Cutting Knife Assembly, for Styles 41300 T, U, V, W; one each Nos. C41, 138, 12538, 22597 E, 41367 C, 41367 G, 41367 J, 41367 R, 41367 S, 41380 S; two each Nos. 22570 A, 22849 -----	-
41370 A	Fabric Uncurler Support Bracket (screw No. 22830)-----	7
41370 B	Fabric Uncurler Support Intermediate Bracket, for Styles 41300 A, 41300 B, 41300 C, 41300 D, 41300 G, 41300 J, 41300 K, 41300 L, 41300 Q, 41300 S (screw No. 22548)-----	11
41370 C	Fabric Uncurler Spring -----	3
41370 G	Fabric Uncurler Support Mounting Bracket, for Styles 41300 A, 41300 B, 41300 C, 41300 D, 41300 G, 41300 J, 41300 K, 41300 L, 41300 Q, 41300 S (attaching screw No. 318, adjusting screw No. 22568)-----	7
41370 H	Fabric Uncurler Lever-----	10
41370 N	Fabric Uncurler Ratchet, front (screw No. 89) ----	7
41370 P	Fabric Uncurler Ratchet, rear -----	7
41370 U	Fabric Uncurler Ratchet Pawl (screw No. 22504 A)-----	7
41370 V	Fabric Uncurler Ratchet Pawl Spring -----	3
41370 AA	Fabric Uncurler Support Mounting Bracket, for knee controlled adjustment of uncurler on No. 29478 R, for Styles 41300 P, 41300 Q, 41300 R, 41300 S, 41300 T, 41300 U, 41300 V, 41300 W (attaching screw No. 318) -----	10
41370 AB	Fabric Uncurler Support Sliding Arm, for knee controlled adjustment of uncurler on No. 29478 R, for Styles 41300 P, 41300 Q, 41300 R, 41300 S, 41300 T, 41300 U, 41300 V, 41300 W (clamp screw No. 93, operating stud No. 21756 G)-----	10

LIST OF PARTS

Symbol to Order By	The figures in the last column refer only to the plates illustrating the parts and are not to be used in ordering. Prices furnished on application.	Plate No.
41370 AC	Fabric Uncurler Support Sliding Arm Gib, for knee controlled adjustment of uncurler on No. 29478 R, for Styles 41300 P, 41300 Q, 41300 R, 41300 S, 41300 T, 41300 U, 41300 V, 41300 W (screw No. 22585) -----	7
41370 AD	Fabric Uncurler Support Sliding Arm Operating Lever, for knee controlled adjustment of uncurler on Styles 41300 F,H,M, N, R, S, T, U, V, W (pivot stud No. 22557) -----	10
41370 AE	Fabric Uncurler Support Sliding Arm Adjustment Stud, for knee controlled adjustment of uncurler on No. 29478 R, for Styles 41300 P, 41300 Q, 41300 R, 41300 S, 41300 T, 41300 U, 41300 V, 41300 W (locking ball No. 12964 C, locking ball spring No. 6258) -----	7
41370 AF	Fabric Uncurler Support Sliding Arm Adjustment Stud Nut, for knee controlled adjustment of uncurler on Styles 41300 F, H, M, N, P, Q, R, S, T, U, V, W (screw No. 90)-----	7
41370 AG	Fabric Uncurler Support Sliding Arm Stop, for knee controlled adjustment of uncurler on No. 29478 R, for Styles 41300 P, 41300 Q, 41300 R, 41300 S, 41300 T, 41300 U, 41300 V, 41300 W (screw No. 22572) -----	7
41370 AH	Fabric Uncurler Ratchet Pawl Arm, for knee controlled adjustment of uncurler on No. 29478 R -----	7
41370 AT	Fabric Uncurler Mounting Bracket, for No. 29478 BV (screw No. 820) -----	-
41370 AV	Mounting Bracket Shaft, for No. 29478 BV -----	-
41370 AW	Mounting Bracket Shaft Spring, for No. 29478 BV --	8
41370 AX	Mounting Bracket Adjusting Stud, for No. 29478 BV (nut No. 41071 G)-----	8
41370 AY	Adjusting Stud Locking Insert, for No. 29478 BV (screw No. 22743) -----	8
41370 BC	Sliding Bracket, for No. 29478 BV (screw No. 94)-----	-
41370 BD	Sliding Bracket Guide, for No. 29478 BV (screw No. 22764, 22845 G)-----	8
41375	Feed Cup Separating Rod -----	15
41375 A	Feed Cup Separating Rod Yoke -----	3
41375 F	Feed Cup Separating Rod Collar (screw No. 22584)-----	4
41375 G	Feed Cup Separating Rod Yoke Spring-----	3
41375 H	Feed Cup Separating Lever Assembly, lower; one each Nos. 424, 660-142, 41375 J, 41375 K ----	15
41375 J	Feed Cup Separating Lever, lower -----	15
41375 K	Feed Cup Separating Lever Bracket -----	14
41375 P	Presser Spring Washer -----	2
41375 Q	Presser Spring-----	3
41375 U	Presser Spring Regulating Screw and Bushing -----	14
41375 V	Presser Spring Regulating Screw Lock Nut -----	4

From the library of: Diamond Needle Corp

LIST OF PARTS

Symbol to Order By	The figures in the last column refer only to the plates illustrating the parts and are not to be used in ordering. Prices furnished on application.	Plate No.
41376 A	Frame Looper Thread Eyelet, for Styles 41300 A, 41300 B, 41300 C, 41300 D, 41300 E, 41300 F, 41300 G, 41300 H, 41300 J, 41300 T, 41300 U, 41300 W (screw No. 87 U or 22585 A)-----	5
41376 B	Frame Needle Thread Eyelet, for Styles 41300 A, 41300 B, 41300 C, 41300 D, 41300 E, 41300 F, 41300 G, 41300 H, 41300 J, 41300 U (screw No. 90)-----	5
41376 G	Needle Thread and Looper Thread Eyelet, for Styles 41300 M, 41300 N, 41300 P, 41300 Q, 41300 R, 41300 S, 41300 T, 41300 V, 41300 W (screw No. 90)-----	5
41377	Needle Thread Auxiliary Tension Bracket, for Styles 41300 A, 41300 B, 41300 C, 41300 D, 41300 E, 41300 F, 41300 G, 41300 H, 41300 J, 41300 T, 41300 U, 41300 W-----	10
41378	Thread Ratio Control Frame, including insert eyelets on Styles 41300 M, 41300 N, 41300 P, 41300 Q, 41300 R, 41300 S, 41300 T, 41300 V, 41300 W (screw No. 22872)-----	8
41378 J	Thread Ratio Control Tension Post (nut No. 43266)-----	8
41378 K	Thread Ratio Control Tension Disc Spacing Collar-----	8
41378 V	Thread Ratio Control Roller, with bushing, for No. 29485 D-----	-
41378 X	Axle Stud, for No. 29485 D-----	8
41380 B	Top Cover, for Styles 41300 E, F, H, M, N, P, R, T, U, V, W (screw No. 75)-----	17
41380 C	Top Cover, cast iron, including gasket for Styles 41300 A, B, C, D, G, J, K, L, Q, S (screw No. 75)-----	15
41380 H	Rear Cover, including gasket, for Styles 41300 A, B, C, D, G, J, K, L, Q, S (screw No. 22516 A)-----	15
41380 J	Rear Cover, for Styles 41300 E, F, H, M, N, P, R, T, U, V, W (screw No. 22516 A)-----	17
41380 N	Cover, for feed cup separating mechanism (screw No. 22849)-----	15
41380 P	Cover, for feed cup separating mechanism on machines equipped with retractable fabric puller and chain cutting knife (screw No. 22849)-----	15
41380 S	Cover, for feed cup separating mechanism (screw No. 22849) taupe finish-----	15
41381	Oil Distributing Disc, for machines without oscillating counterweight (screw No. 605 A, dowel pin No. 50-216 Blk)-----	9
41381 A	Oil Distributing Plate, for machines without oscillating counterweight (screw No. 22516 A)-----	14
41381 C	Oil Distributing Disc, with counterweight, for machine equipped with oscillating counterweight (screw No. 605 A)-----	9
41381 G	Oil Spray Deflector Plate (screw No. 93 A)-----	15

LIST OF PARTS

Symbol to Order By	The figures in the last column refer only to the plates illustrating the parts and are not to be used in ordering. Prices furnished on application.	Plate No.
41383	Chain Cutter, for Styles 41300 A, 41300 B, 41300 C, 41300 D, 41300 E, 41300 F, 41300 G, 41300 H, 41300 J, 41300 K, 41300 L, 41300 M, 41300 N, 41300 P, 41300 Q, 41300 R, 41300 S (screw No. 22570 A)-----	10
41383 C	Chain and Needle Guard, for Styles 41300 A, 41300 B, 41300 C, 41300 D, 41300 F, 41300 G, 41300 H, 41300 J, 41300 P, 41300 Q, 41300 R, 41300 S (screw No. 22570 A)-----	10
41383 D	Chain and Needle Guard, for Styles 41300 K, 41300 L, 41300 M, 41300 N (screw No. 22570 A)-----	10
41383 E	Chain Cutter Extension Plate, for Styles 41300 K, 41300 L, 41300 M, 41300 N, (screw No. 22570 A) --	3
41383 F	Selvage Guard, for Styles 41300 E, T, U, V, W (screw No. 22585 C)-----	6
41390 A	Crankshaft Bearing Housing, right and left, includes bushing, for machines without oscillating counterweight; also left, for machines equipped with oscillating counterweight (screw No. 79)-----	10
41390 C	Crankshaft Bearing Housing, right, includes bushing, for machines equipped with oscillating counterweight (screw No. 79)-----	10
41390 D	Crankshaft Bushing, right and left, for machines without oscillating counterweight; also left, for machines equipped with oscillating counterweight-----	4
41390 E	Crankshaft Bushing, right, for machines equipped with oscillating counterweight-----	4
41391	Crankshaft Thrust Washer-----	2
41391 G	Pulley Rim, for Styles 41300 A, B, C, D, G, J, K, L, Q, S (screw No. 22565 C)-----	10
41391 H	Pulley Rim, for Styles 41300 E, F, H, M, N, P, R, T, U, V, W (screw for 22565 C)-----	13
41392	Tension Post Ferrule, for machines without thread ratio control-----	5
41393	Oil Level Gauge Assembly; one each Nos. 39193 B, 41393 B-----	3
41393 B	Oil Level Sight Gauge-----	3
41394	Gasket, for crankshaft bearing housing-----	10
41394 A	Gasket, for needle bar adjusting screw hole-----	2
41394 B	Gasket, for top cover-----	15
41394 C	Gasket, for rear cover-----	13
41394 D	Gasket, for looper lever shaft hole-----	3
41394 G	Washer, for needle bar adjustment screw hole-----	2
41395 A	Machine Mounting Gasket-----	-
41395 B	Machine Mounting Locating Pin-----	8
41395 C	Machine Mounting Rubber Isolator-----	-
41396	Machine Mounting Screw Locking Pin, brass-----	3
41397 A	Stitch Tongue, marked "DE", for Styles 41300 B, 41300 D, 41300 G, 41300 J, 41300 Q-----	6

From the library of: Diamond Needle Corp

LIST OF PARTS

Symbol to Order By	The figures in the last column refer only to the plates illustrating the parts and are not to be used in ordering. Prices furnished on application.	Plate No.
41397 B	Stitch Tongue, marked "DF", for Styles 41300 A, 41300 C, 41300 F, 41300 H, 41300 P, 41300 T, 41300 U, 41300 V, 41300 W-----	6
41397 D	Stitch Tongue, marked "DG"-----	6
41397 E	Stitch Tongue, marked "DH", for Style 41300 E----	6
-	NOTE: For mock seaming on fine work use No. 41397 D	-
41397 F	Stitch Tongue, marked "DJ", for Styles 41300 K, 41300 L, 41300 M, 41300 N, 41300 R, 41300 S----	6
-	Stitch Tongue Screws No. 22798 A	-
43266	Nut, for thread ratio control tension post, on Styles 41300 M, 41300 N, 41300 P, 41300 Q, 41300 R, 41300 S, 41300 T, 41300 U, 41300 V, 41300 W-----	2
51242 M	Washer, for oscillating counterweight screws; also for thread ratio control frame-----	2
51292	Tension Post, for Styles 41300 A, 41300 B, 41300 C, 41300 D, 41300 E, 41300 F, 41300 G, 41300 H, 41300 J, 41300 T, 41300 U, 41300 W----	5
51292 C	Tension Regulating Nut-----	2
51292 D	Needle and Loper Thread Tension Eyelet Assembly (steel insert No. 668-25, ferrule No. 668-28)-----	5
51292 F-1	Thread Ratio Control Tension Spring-----	3
K56697	Wale Guide Base, upper, for assemblies Nos. 21197 P, 21197 Q (screw No. 22813)-----	17

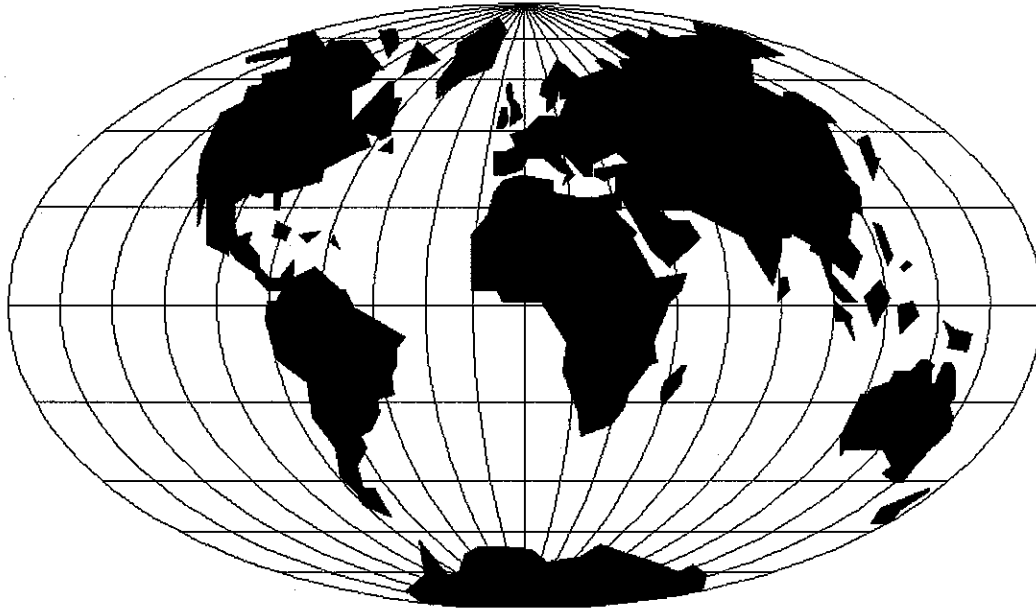

WORLDWIDE SALES AND SERVICE

Union Special Corporation maintains sales and service facilities throughout the world. These offices will aid you in the selection of the right sewing equipment for your particular operation. Union Special Corporation representatives and service technicians are factory trained and are able to serve your needs promptly and efficiently. Whatever your location, there is a qualified representative to serve you.

Corporate Office: One Union Special Plaza
Huntley, IL 60142
Phone: 708•669•5101
Fax: 708•669•1096

European Distribution Center: Union Special GmbH
Raiffeisenstrasse 3
D-71696 Möglingen, Germany
Tel: 49•07141•247•0
Fax: 49•7141•247•100

Brussels, Belgium
Charlotte, N.C.
Commerce, CA
El Paso, TX
Hong Kong, China
Huntley, IL
Leicester, England
Lille, France
Miami, FL
Milan, Italy
Mission, TX
Möglingen, Germany
Montreal, Quebec
Osaka, Japan

Other Representatives throughout
all parts of the world.



Union Special
INDUSTRIAL SEWING EQUIPMENT